

# Digital technologies in agriculture

---

**Madaras, Z; Schmit, P.; Gantner, Ranko; Neubauer, A.; Garré, A.; Kožul, M.; Fruk, G.; Hederić, Ž.; Šunić, A.; Lončarić, Zdenko; ...**

**Edited book / Urednička knjiga**

*Publication status / Verzija rada:* **Published version / Objavljena verzija rada (izdavačev PDF)**

*Publication year / Godina izdavanja:* **2022**

*Permanent link / Trajna poveznica:* <https://um.nsk.hr/um:nbn:hr:151:225168>

*Rights / Prava:* [In copyright](#)/[Zaštićeno autorskim pravom.](#)

*Download date / Datum preuzimanja:* **2024-08-25**



Sveučilište Josipa Jurja  
Strossmayera u Osijeku

**Fakultet  
agrobiotehničkih  
znanosti Osijek**

*Repository / Repozitorij:*

[Repository of the Faculty of Agrobiotechnical  
Sciences Osijek - Repository of the Faculty of  
Agrobiotechnical Sciences Osijek](#)



Book of Abstracts

# DIGITAL TECHNOLOGIES IN AGRICULTURE

No. 1 / 2022



**1** ISDTA  
&  
DIGITAGRA 2022  
6 - 8 December  
Osijek | Croatia

# The ISDTA 2022

(1st International Symposium on  
Digital Technologies in Agriculture)

and

# DIGITAGRA 2022

(1st Satellite Workshop  
– Digital Agriculture in Rural Area)

## **Organizer**

Faculty of Agrobiotechnical Sciences

## **Publisher**

Faculty of Agrobiotechnical Sciences

## **Editors**

Zdenko Lončarić

Jurica Jović

## **Design**

Ras Lužaić

ISBN: 978-953-8421-03-7

**Osijek, 6 - 8 December 2022**

## Symposium Objectives

The 1st International Symposium on Digital Technologies in Agriculture will enhance the exchange and dissemination of knowledge, experience, ideas and results. The aim is to promote internationalization and friendships among researchers and professionals in all research fields associated with digital technologies in agriculture, with a focus on precision agriculture, agronomist education in digital agriculture, data collection and all the other aspects of digital technologies in agriculture.

The key topic of the 1st International Symposium on Digital Technologies in Agriculture is an interdisciplinary application of technologies toward sustainable digital agriculture.

## Symposium Topics

- Data collection
- Precision crop production
- Decision support systems and models in digital agriculture
- Digital technologies in agriculture
- Digital agroeconomic and marketing
- Agronomist education in digital agriculture

## DIGITAGRA 2022 Workshop Objectives

The main purpose of the 1st Satellite Workshop Digital Agriculture in Rural Area will be:

- Disseminate the idea, goals and methods of digital agriculture in the rural area
- Discuss the opportunities and challenges for small farmers in the transformation toward digital agriculture
- Connecting the stakeholders in the digitalization of agriculture at local and regional levels

# Organizers

**Faculty of Agrobiotechnical Sciences, Josip Juraj Strossmayer University of Osijek**  
**Centre for Applied Life Science Healthy Food Chain Ltd. Osijek**

and

**Agricultural Institute Osijek, Croatia**

**Balkan Environmental Association (B.E.N.A.)**

**Croatian Agency for Agriculture and Food, Osijek**

**Faculty of Food Technology Osijek, Croatia**

**Faculty of Electrical Engineering, Computer Science and Information Technology Osijek**

**University of Zagreb Faculty of Agriculture Zagreb, Croatia**

**Faculty of Agricultural Sciences and Food, Skopje, North Macedonia**

**Faculty of Agriculture and Biotechnology, Bydgoszcz, Poland**

**Josip Juraj Strossmayer University of Osijek, Croatia**

under the auspices of the

**Ministry of Agriculture of the Republic of Croatia**

**Ministry of Science and Education of the Republic of Croatia**

In collaboration with

**City of Požega**

**City of Slavonski Brod**

**City of Vinkovci**

**City of Virovitica**

**City of Vukovar**

**College of Agriculture in Križevci**

**County of Brod-Posavina**

**County of Osijek-Baranya**

**County of Vukovar-Srijem**

**County of Požega-Slavonia**

**County of Virovitica-Podravina**

**Croatian Chamber of Economy**

**University of Applied Sciences in Požega**

**University of Slavonski Brod**

**AGRIVI**

**HUAWEI**

**Žito d.o.o**

# Organizing Committee

## **Chairman**

Krunoslav Zmaić, Croatia

## **Members**

Zvonimir Zdunić, Croatia

Mariana Golumbeanu, Romania

Ivica Kisić, Croatia

Tomislav Matić, Croatia

Jurislav Babić, Croatia

Vjekoslav Tanaskovik,

North Macedonia

Vlado Guberac, Croatia

Ivana Majić, Croatia

Lech Gałęzewski, Poland

Matija Žulj, Croatia

## **Secretary**

Jurica Jović, Croatia

## **Secretary deputy**

Vinko Božić, Croatia

# Scientific Committee

## **Chairman**

Zdenko Lončarić, Croatia

## **Student Chairman**

Ana Šunić, Croatia

## **Members**

Ivan Plaščak

Faculty of Agrobiotechnical Sciences Osijek, Croatia

Tomislav Vinković

Faculty of Agrobiotechnical Sciences Osijek, Croatia

Zacharoula Andreopoulou

Faculty of Forestry and Natural Environment, Aristotle University of Thessaloniki, Greece

Ružica Lončarić

Faculty of Agrobiotechnical Sciences Osijek, Croatia

Zvonko Antunović

Faculty of Agrobiotechnical Sciences Osijek, Croatia

Robert Burns

University of Tennessee Knoxville, Knoxville, Tennessee, United States

Vladimir Ivezić

Faculty of Agrobiotechnical Sciences Osijek, Croatia

Vlatko Galić

Agricultural Institute Osijek, Croatia

Yusuf Kurucu

Agricultural Faculty of Ege University, Izmir, Turkey

Časlav Livada

Faculty of Electrical Engineering, Computer Science and Information Technology Osijek, Croatia

Krunoslav Aladić

Faculty of Food Technology Osijek, Croatia, Croatia

Mile Markoski

Faculty of Agricultural Sciences and Food, Skopje University „St. Cyril and Methodius“, North Macedonia

Hrvoje Kutnjak

University of Zagreb Faculty of Agriculture Zagreb, Croatia

Vesna Gantner

Faculty of Agrobiotechnical Sciences Osijek, Croatia

Tihana Sudarić

Faculty of Agrobiotechnical Sciences Osijek, Croatia

# Sponsors





# Sadržaj

- 3 **Zoltan Madaras**  
VITICULTURAL DEVELOPMENTS WITH THE APPLICATION OF DIGITAL TECHNOLOGY SOLUTIONS AT THE RESEARCH INSTITUTE IN PÉCS
- 5 **Paul Schmit, Ranko Gantner, Anna Neubauer, Anna Garré**  
EVALUATING HORSE DRAWN TILLAGE TECHNOLOGY THROUGH DIGITAL DATA LOGGING
- 6 **Mario Kožul, Goran Fruk, Željko Hederić**  
DESIGN AN AUTONOMOUS ROVER FOR USE IN PRECISION AGRICULTURE
- 8 **Ana Šunić, Zdenko Lončarić**  
CROWDSOURCING DATA ON ARABLE CROPS FERTILIZATION IN CROATIA
- 11 **Mario Kožul, Ivan Aleksi, Željko Hederić**  
ENERGY MANAGEMENT OF AN AUTONOMOUS ROBOTIC PLATFORM FOR APPLICATION IN ORCHARDS
- 12 **Dušan Dunderski, Ivana Varga, Dario Iljkić, Dubravka Užar**  
EVALUATION OF HEMP SEEDLING SIZE USING IMAGEJ SOFTWARE
- 13 **Nenad Bestvina**  
INFORMATION SYSTEMS SUPPORTING PLANT PRODUCTION
- 14 **Luka Šumanovac, Petra Pejić**  
IMAGE-PROCESSING METHOD FOR APPLE RECOGNITION AND ROBOTIC MANIPULATION
- 15 **Lech Gałęzewski, Edward Wilczewski, Marek Kościński, Iwona Jaskulska, Jacek Majcher, Andrzej Wilczek**  
RELIABILITY OF SOIL MOISTURE MEASUREMENT AS A FACTOR DETERMINING THE EFFECTIVENESS OF PRECISION AGRICULTURE
- 16 **Karolina Kajan, Vlatko Galić**  
ANDROID APPLICATION FOR ORGANIZING PLANT BREEDING PROGRAMS
- 17 **Davor Bilić, Zdenko Lončarić**  
SUITABILITY AND SUFFICIENCY OF DATA OBTAINED BY UAV FOR VARIABLE TOPDRESSING OF CROPS
- 18 **Domagoj Grgić, Marija Ravlić**  
WEED CONTROL USING DRONES AND ROBOTS
- 21 **Ana Marija Antolković, Martina Skendrović Babojelić, Rea Vrtodušić, Mihaela Šatvar Vrbančić, Marko Petek, Antonio Viduka, Tomislav Karažija, Goran Fruk**  
DATASET OF AN APPLE ORCHARD FOR OBJECT DETECTION

- 22 **Dana Čirjak, Ivan Aleksi, Ivana Miklečić, Darija Lemić, Tomislav Kos, Ivana Pajač Živković**  
THE USE OF ARTIFICIAL NEURAL NETWORKS AS A TOOL FOR DETECTION OF LEPIDOPTERAN APPLE PESTS
- 23 **Sandra Skendžić, Monika Zovko, Vinko Lešić, Marko Maričević, Ivana Pajač Živković, Darija Lemić**  
DETECTION AND EVALUATION OF ENVIRONMENTAL STRESS IN WINTER WHEAT USING PROXIMAL SENSING METHODS
- 24 **Daria Galić Subašić, Mladen Jurišić, Dorijan Radočaj, Ivan Plaščak, Irena Rapčan**  
SOYBEAN YIELD PREDICTION BASED ON IRRIGATION AND NITROGEN FERTILIZATION USING MACHINE LEARNING
- 25 **Ružica Lončarić, Sanja Jelić Milković, Tihana Sudarić, Zdenko Lončarić**  
A MODEL FOR CALCULATING THE TECHNICAL POTENTIAL OF BIOMASS FROM AGRICULTURE
- 26 **Maja Karnoš, Vesna Rastija, Domagoj Šubarić**  
IN SILICO PESTICIDE DISCOVERY – A COMPUTATIONAL SCREENING OF COUMARINYL 1,2,4-TRIAZOLES
- 27 **Milena Andrišić, Hrvoje Hefer, Daniel Rašić, Ivana Zegnal, Domagoj Mikulić, Zdenko Lončarić**  
OPTIMIZING SOIL MANAGEMENT BY MODELING THE AVAILABILITY OF IRON IN AGRICULTURAL SOILS
- 28 **Hrvoje Hefer, Milena Andrišić, Ivana Zegnal, Daniel Rašić, Domagoj Mikulić, Zdenko Lončarić**  
MODELING OF ZINC AVAILABILITY IN THE SOILS OF EASTERN CROATIA
- 29 **Vlatko Galić, Domagoj Šimić**  
AGRICULTURAL REALITY VS. DATA DENSITY – PARSIMONIOUS APPROACH WITH KERNEL METHODS
- 32 **Dragan Solić, Darko Bosnar, Karlo Liović, Vesna Gantner**  
DEVELOPMENT OF AN AUTOMATIC BODY CONDITION SCORE SYSTEM FOR DAIRY COWS
- 33 **Filip Jaman, Zlatko Puškadija, Marin Kovačić**  
DIGITAL AGRICULTURE IN BEEKEEPING – DEVICE FOR REVEALING THE SWARMING STATE OF A HONEY BEE COLONY
- 34 **Željka Klir Šalavardić, Josip Novoselec, Zvonko Antunović**  
APPLICATION OF ELECTRONIC IDENTIFICATION (EID) IN SMALL RUMINANTS
- 35 **Mislav Đidara, Zdenko Ivkić, Matej Brlić, Ivana Prakatur, Martina Pavlić, Marcela Šperanda**  
APPLICATION OF PLF TOOLS FOR MONITORING HEALTH OF DAIRY COWS
- 36 **Martina Hasija, Maja Gregić, Tihomir Živić, Tina Bobić, Pero Mijić, Katarina Miljak, Mirjana Baban**  
THE APPLICATION OF INFORMATION AND COMMUNICATIONS TECHNOLOGIES IN HORSE BREEDING

- 39 **Snježana Tolić, Ivan Lauc, Duško Rajičević**  
INFORMATIONAL PLATFORMS AS KEY ENABLERS OF EFFICIENT AND TRANSPARENT  
SHORT FOOD SUPPLY CHAIN DELIVERY PROCESS
- 40 **Goran Markovanović, Mario Salai, Izabela Novaković, Saša Lamza, Goran Kušec**  
INNOVATIVE SUPPLY CHAINS AND LOCAL FOOD PRODUCTION  
– A CASE STUDY OF THE PLANTON PLATFORM
- 41 **Dubravka Užar, Ivana Varga, Dušan Dundžerski, Dario Iljkić**  
IMPORTANCE OF USING SOCIAL MEDIA IN PROMOTING FOOD PRODUCTS
- 44 **Tihomir Živić**  
MULTIMEDIA TOOLSET DEPLOYMENT IN THE ENGLISH-COURSE PRESENTATION  
OF DIGITAL AGRICULTURE
- 46 **Dominik Tačković, Ružica Lončarić, Sanja Jelić Milković, Zdenko Lončarić**  
COMPETENCE, PERSPECTIVE AND POTENTIAL ROLE OF AGRONOMISTS  
IN AGRICULTURE DIGITALIZATION IN CROATIA
- 47 **Dinko Domazetović, Ružica Lončarić, Sanja Jelić Milković, Zdenko Lončarić**  
KNOWLEDGE ON DIGITAL AGRICULTURE AMONG THE OWNERS OF FAMILY FARMS  
IN OSIJEK-BARANJA COUNTY
- 48 **Lucija Magdić, Snježana Tolić, Josip Job**  
APPLICATION OF THE CONCEPT OF SMART VILLAGES TO THE DEVELOPMENT  
OF THE VILLAGE OF BANOVA JARUGA

## Section 1

---

# Data collection



# VITICULTURAL DEVELOPMENTS WITH THE APPLICATION OF DIGITAL TECHNOLOGY SOLUTIONS AT THE RESEARCH INSTITUTE IN PÉCS

**Zoltan Madaras**

University of Pécs, Research Institute for Viticulture and Oenology, Pázmány Péter u. 4, 7634 Pécs, Hungary

## Abstract

The sustainability is constantly shaping the future of agriculture. At the heart of the transformation of agriculture is the development and embracing of new technologies. The gene bank "big data" researches currently being conducted at the Research Institute of Viticulture and Oenology in Pécs will be the basis for future precision farming. Using the data collected in the digital gene bank catalog in our possession, the next generation of precision farming will be able to operate.

At the Research Institute of Viticulture and Oenology of the University of Pécs, we strive to ensure that our research brings quick and useful results to producers.

To this end, we have started to build a digital vine registration and data collection system. This unique development, due to the location, size and capabilities of the Research Institute, can effectively serve the digital scale change of micro and small enterprises.

Due to the peculiarities of the field, the interactive presentation of the latest technologies is a suitable test environment, and the experience of the institute's specialists can also be used excellently.

An important decision support tool for growers is the systematization (meteorology, soil moisture, phenology, crop parameters, nutrient supply, must and wine composition, etc.) of the database collected during the 70 years of existence of the Research Institute.

With the digitalization and database development of grape gene banking items, we are developing a new perspective compared to previous gene banking research, and we also support domestic and international viticulture research in a database subscription-based and service-based system.

The aim of the system is to keep a register of each vine bearing a unique identifier. About 150 types of properties of the capitals are recorded, and the development is recorded on continuous photo documenta-

tion. In addition, the unique sequence number on the RFID (Radio Frequency IDentification) identifier helps to specifically indicate the area and capital to be cultivated during the work processes.

Subsequent purpose of the system

- all influences that influence its development should be collectible. In other words, each cultivation phase and environmental impact can be collected manually and electronically.

- the system should be able to store the data (physical and chemical values) measured by sensors later fitted to the system for the corresponding capitals. Furthermore, it can be further developed to create algorithms and mathematical models using the stored data, which helps to determine the infestation and other characteristics of grapes.

These recorded values can be processed retrospectively or online, and calculations, analyses and forecasts can be made from the collected data. This system can also be useful for a data-based decision, such as spraying.

The mechanization has nowadays a particular importance in the practice of the grapevine growing. In recent decades, the mechanization of more and more viticultural technology operations has been solved in the most diverse grapevine plantation types. Phyto-technical operations (pruning, canopy works) and the harvest are undoubtedly the most time-consuming interventions for practicing viticulturists. Nowadays, the mechanization of the harvest can be effectively implemented in most plantations, as can a significant part of the canopy works or the pre-pruning of the vines.

In addition, it should be noted that some operations requiring human expertise and a large investment of working time, such as finalized pruning, shoot or cluster thinning cannot be achieved with the help of machines operating on the mechanical principle.

With the development of artificial intelligence, the implementation of these specific phytotechnical operations will become feasible in the near future.

Many research groups around the world are working on the development of the mechanization of pruning with artificial intelligence. The creation of the grape-pruning robots was motivated everywhere by the shortage of labor in agriculture or by the lack of sufficiently skilled labor, as well as by increasing cost efficiency.

In this publication, first we present the types of pruning robots currently known in the world, and then we report on the development that we have been carrying out in Hungary since the previous year in the consortium cooperation of InnovITech Ltd., SBS Ltd., Bay Zoltán Nonprofit Ltd., and the University of Pécs. The goal of our development is to create an autonomously functioning GPS-controlled robot that can perform the necessary pruning independently after recognizing the organs of the vines.

# EVALUATING HORSE DRAWN TILLAGE TECHNOLOGY THROUGH DIGITAL DATA LOGGING

Paul Schmit<sup>1</sup>, Ranko Gantner<sup>2</sup>, Anna Neubauer<sup>3</sup>, Anna Garré<sup>4</sup>

<sup>1</sup> Schaff mat Pæerd asbl, 27, rue de Brouch, 7481 Tuntange, Luxembourg (schaffmatpaerd@pt.lu)

<sup>2</sup> Josip Juraj Strossmayer University of Osijek, Faculty of Agrobiotechnical Sciences Osijek, Vladimira Preloga 1, 31000 Osijek, Croatia

<sup>3</sup> University of Kassel, Faculty of Organic Agricultural Sciences, Steinstraße 19, 37213 Witzenhausen, Germany

<sup>4</sup> Stockholm Resilience Centre, Kräftriket 2B, 10691 Stockholm, Sweden

## Abstract

The aim of the paper is to present the importance of digital data logging for recording the draft forces in the development of improved horse-drawn inter-row cultivators.

A number of recent researches has shown that horse traction offers a viable option for sustainable farming despite the era of robotization and space technology in large-scale agriculture. Horse traction is appreciated because it offers an independence of distant fossil fuel resources, it is suitable for uneven, small and inclined land plots in hilly and mountainous regions, draft animals and animal-drawn implements can be purchased at low costs and simply maintained, and draft animals cause relatively little soil compaction thus enabling for recovery of soil pores and water holding capacity.

Traditional horse drawn implements can be improved for modern low-input farming systems. In the case of traditional single-row cultivators, there was found great variation of draft forces during its operation due to imperfect control of working depth. On newly developed inter-row cultivators (Schaff mat Pæerd asbl, Figure 1), penetration into soil is limited by accurate skids or jockey wheels on parallelogram suspensions. Such limitation of working depth has lowered the draft force, and thereafter enabled for simultaneous cultivation of up to three rows of row crops, at draft forces appropriate for a single horse.



Figure 1. Newly developed inter-row cultivator

Such an improvement offers near threefold increasing in work efficiency.

Measurements of draft forces in horse drawn implements are being conducted with dynamometers equipped with digital data loggers. Draft force measurements taken in the field are being stored and graphically viewed on PC, thus providing a constructor with the data. A draft force of 0,78 kN at a working speed of 1 to 1,25 m/s is considered as an average continuous physical effort of a medium sized work horse in longer work effort without excessive strain, also on several consecutive days, at field work.

**Keywords:** horse drawn tillage, animal traction, draft force measurement

## Acknowledgement

The results presented in the paper are an output from the project work „Examination of hoeing technology for single-horse use“ of Anna Neubauer and the Master's Thesis „Farming with Draft Animals: Using Retro Innovations for Sustainable Agrarian Development - A case study of organic small-scale farming in Northern Italy“ of Anna Garré.



# DESIGN AN AUTONOMOUS ROVER FOR USE IN PRECISION AGRICULTURE

Mario Kožul<sup>1</sup>, Goran Fruk<sup>2</sup>, Željko Hederić<sup>3</sup>

<sup>1</sup> MMM Agramservis d.o.o., Samoborska 145g, 10000 Zagreb, Croatia (mario.kozul@agramservis.hr)

<sup>2</sup> University of Zagreb, Faculty of Agriculture, Svetošimunska cesta 25, 10000 Zagreb, Croatia

<sup>3</sup> Josip Juraj Strossmayer University of Osijek, Faculty of Electrical Engineering, Computer Science and Information Technology Osijek, Kneza Trpimira 2B, Osijek Croatia

## Abstract

The current trends in agronomy follow the digitalisation in the sector, which is already going through the phase of Industry 4.0, and management strategies, data collection and analysis is directed towards the general objective of increasing efficiency, sustainability and productivity by use of technology, automated systems and robotics. The AgriArt project aims to develop an overarching management system in the

field of precision agriculture, focusing on increasing organically produced fruits using the key concepts of IoT and artificial intelligence. For this purpose, a system needs to be developed to monitor the growth of all plant and fruit elements over a large area of the orchard with high precision of sampling position and quality of analysis.

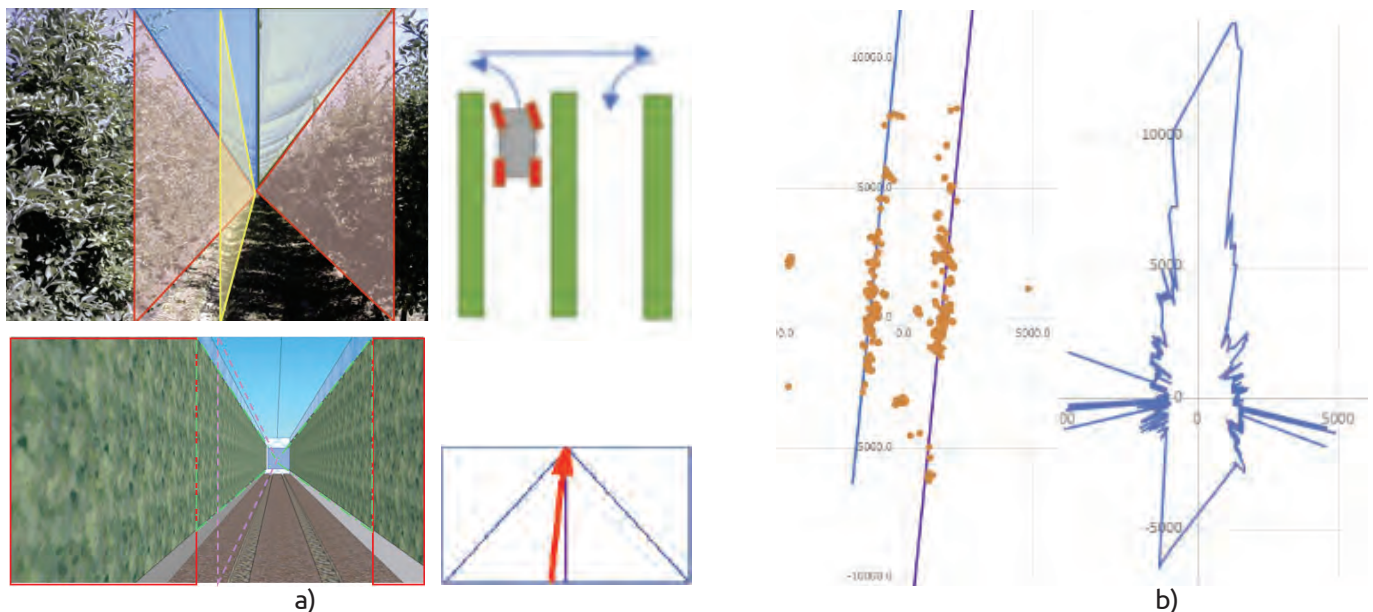

Fig. 1. Using a video camera (a) and lidar (b) to correct the position of the autonomous rover in the orchard vector map

The design of an autonomous rover as a portable platform for a set of high-resolution cameras is a challenge that not only ensures a safe trajectory through the orchard according to well-defined GPS coordinates, but also has to ensure power supply for all necessary subsystems (cameras, computers, internet router). In

addition, the rover must move independently, overcome obstacles and communicate with the command centre. Complex sensor systems are used: lidar, optical camera and ultrasonic sensors that detect the surrounding space and determine the rover's position in the vector field map of the orchard. This requi-

res the development of a special element to dampen the slope of the terrain and dampen vibrations while driving, i.e. to dampen vibrations in a stationary po-

sition while recording. The drive of the autonomous vehicle is electric with the use of solar energy as the energy source.

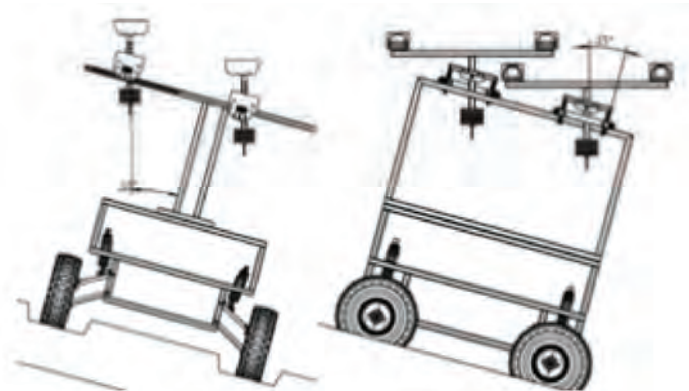

**Fig. 2.** The autonomous rover has a special system for pointing the surveillance cameras that consumes no energy and provides a stable position with vibration damping

**Keywords:** autonomous field robots, electric drives, lidar, precision agriculture, artificial intelligence

## Acknowledgement

The results presented in the paper are an output from a research project supported through the European Regional Development Fund „AgriART comprehensive management system in the field of precision agriculture“ (KK.01.2.1.02.0290).

# CROWDSOURCING DATA ON ARABLE CROPS FERTILIZATION IN CROATIA

Ana Šunić<sup>1</sup>, Zdenko Lončarić<sup>2</sup>

<sup>1</sup> Master study Digital agriculture, Josip Juraj Strossmayer University of Osijek, Faculty of Agrobiotechnical Sciences Osijek, Vladimira Preloga 1, 31000 Osijek, Croatia (ana.sunic@fazos.hr)

<sup>2</sup> Josip Juraj Strossmayer University of Osijek, Faculty of Agrobiotechnical Sciences Osijek, Vladimira Preloga 1, 31000 Osijek, Croatia

## Abstract

Digital agriculture involves different ways of collecting data, and the biggest involvement of farmers in the data collection process is crowdsourcing, i.e. outsourcing data collection by a network of farmers. Thereby, farmers are not actually employed to collect data, but voluntarily participate in data exchange, and such a form of data collection can also be called farmsourcing. The aim of this paper is to describe the significance of crowdsourcing data collection in arable crops production in Croatia. In the Republic of Croatia, it is mandatory to analyze the soil every 4 years in agricultural production whereby the identification of the agricultural parcel, the applicant for the analysis and information about the planned crop are necessary for the fertilization plan. However, a whole series of additional data is important for optimizing fertilization and preserving soil fertility, and that is why data collection from farmers is organized when submitting a request for soil analysis. The mentioned farmsource format was used from 2018 for collection 4 groups of data: 1. type (species) and yields of crop and pre-crop; 2. type, amount and year of applied organic fertilizers; 3. data on harvest residues (removal or incorporation into the soil); 4. data on previous mineral fertilization. During 4 years (2018-2021) data were collected from 13,239 requests for soil analysis. The most complete data were collected for the planned crop (99.6%) but only 69.13 % data were collected for target yields in production. Similarly, 97.57 % farmers shared information on pre-crop type, but only 8,260 (62.4%) provide data on the realized yield of the pre-crop. These data show that in 4 years only in 3.4% of cases farmers achieved a yield <60% of the planned yield, and in 9.8% of cases they achieved >110% of the planned yield. Most often (52.2% of cases) 60-90% of the planned yield was achieved, and in the remaining cases (34.64%) the yield was achieved as planned (90-110% of the planned). At the same time, only 57.5% of farmers fully shared data

on the level of previous fertilization with N, P and K. A five different levels of mineral fertilization were recorded: 1. without fertilization (3,8%); 2. up to 40% of the required (recommended) fertilization (2,5%); 3. 40-70% of the required fertilization (19.3-19.7%); 4. fertilization as needed (73.6-74.2%); 5. >120% of the recommended fertilization (0,3%). The results show that as many as 93.5% of farmers fertilized as recommended or with a certain reduction, which is in accordance with the data that in 86.8 cases the expected or somewhat lower (60-90% of the expected) yield was achieved. Collected data show that organic fertilization was applied to only 15,34% of the analyzed soils. The most common was the use of cattle (78.8%) and pig (11.5%) manures. The presented results show that the data collected by crowdsourcing indicate a close connection between the recommended and applied fertilization and the achieved yields.

**Keywords:** fertilization level, organic fertilization, pre-crop, yield

## Acknowledgement

This work was supported by the Huawei „Seeds For The Future Scholarship Programm“.

## Section 2

---

# Precision crop production



# ENERGY MANAGEMENT OF AN AUTONOMOUS ROBOTIC PLATFORM FOR APPLICATION IN ORCHARDS

Mario Kožul<sup>1</sup>, Ivan Aleksi<sup>2</sup>, Željko Hederić<sup>2</sup>

<sup>1</sup> MMM Agramservis d.o.o., Samoborska 145g, 10000 Zagreb, Croatia (mario.kozul@agramservis.hr)

<sup>2</sup> Josip Juraj Strossmayer University of Osijek, Faculty of Electrical Engineering, Computer Science and Information Technology Osijek, Kneza Trpimira 2B, Osijek Croatia

## Abstract

The use of autonomous robotic platforms for various tasks in orchards is based on the use of electric drives, which are highly dependent on the energy of the storage system. It's very important to define the conditions under which the vehicle will move through the space of the orchard, i.e. through specific rows, manipulations between rows and within rows. The relief of the orchard, the slope along the rows and the slope perpendicular to the row direction play an important role. In addition, there's the moisture of the soil (mud, traces of heavy machinery) and the requirements for the speed of movement.

Predicting the trajectory under the above boundary conditions is the first step in the development of energy storage systems, from the question of capacity and battery type to the question of the possibility of recharging and the use of renewable energy sources.

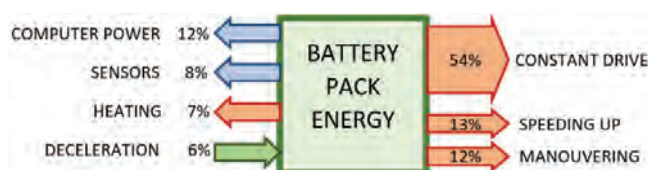

Fig. 1. Energy distribution of the autonomous robot drive in orchard

There are various work tasks for autonomous robots in the orchard - from pest and disease control to other tasks. The dynamics of these tasks are determined by the agronomist himself based on the meteorological and biological conditions on site. On this basis, the possible travel distances of the vehicle must be determined, which will determine the design of the energy storage system, the required distance from the work area to the charging station and the work requirements for energy must be considered, while

providing sufficient capacity for the agrotechnical requirements. Excessive battery storage capacity for redundancy steers the design into an area of excessive weight and results in even higher energy requirements, which is why the optimisation process must be carried out in the simulation domain before prototyping.

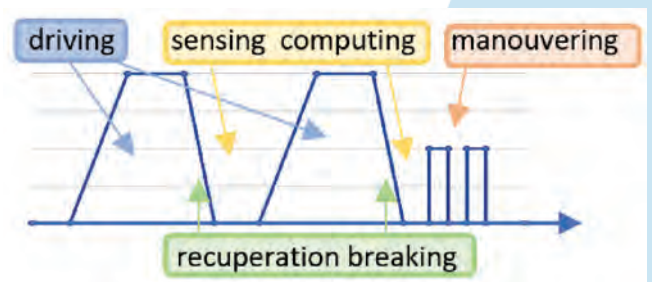

Fig. 2. Energy drain during cycles

**Keywords:** autonomous field robots, energy management, optimization process, precision agriculture, artificial intelligence

## Acknowledgement

The results presented in the paper are an output from a research project supported through the European Regional Development Fund „AgriART comprehensive management system in the field of precision agriculture“ (KK.01.2.1.02.0290).

# EVALUATION OF HEMP SEEDLING SIZE USING IMAGEJ SOFTWARE

Dušan Dundžerski<sup>1</sup>, Ivana Varga<sup>2</sup>, Dario Iljkić<sup>2</sup>, Dubravka Užar<sup>1</sup>

<sup>1</sup> University of Novi Sad, Faculty of Agriculture, Trg Dositeja Obradovića 8, 21102 Novi Sad, Serbia (dundzerskid@gmail.com)

<sup>2</sup> Josip Juraj Strossmayer University of Osijek, Faculty of Agrobiotechnical Sciences Osijek, Vladimira Preloga 1, 31000 Osijek, Croatia

## Abstract

In vitro hemp seed germination is crucial for investigating factors impacting production conditions. It is laborious and time-consuming to measure and evaluate the morphological traits of seedlings grown in vitro. One of the most well-known machine vision techniques is image processing, which offers detailed information and more reliability and accuracy than traditional counting and visual determination of seedlings.

The study aimed to determine if hypocotyl images obtained with semi-automatic processing through SmartRoot could be replaced with faster, automatic processing.

Seedlings were scanned in RGB color profile in 300 dpi, using an open lid flatbed scanner HP Scanjet G4050. The images were processed in ImageJ software. The steps in image processing are shown in figure 1.

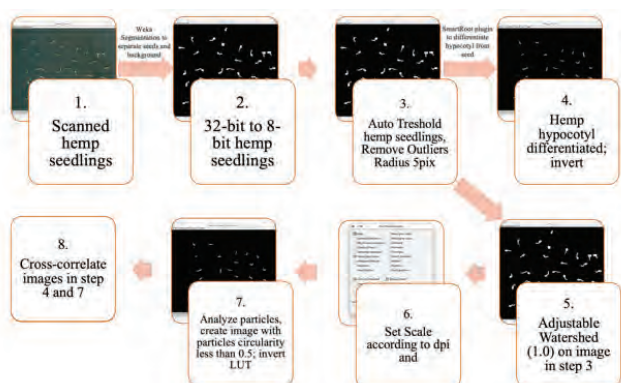

Figure 1: Steps from original (scanned) images to hemp hypocotyl images used for comparison.

One scanned image was used to create ARFF segmentation data from Weka Segmentation training. The images in step 8 obtained with SmartRoot were compared with images in step 7 using cross-correlation with Fast Fourier transform (figure 2).

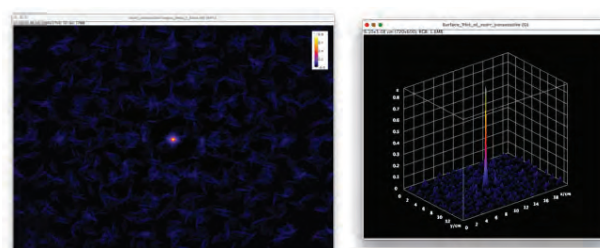

Figure 2: Function map and 3D surface plot of cross-correlation

The average cross-correlation coefficient between hypocotyl images was 0.86. The average diameter and length with the automatic process were 0.108 and 0.745, respectively, and with SmartRoot 0.104 and 0.759, respectively. Using a t-test it was concluded that the average length and diameter obtained with the two methods didn't show a statistically significant difference. Comparing length and diameter acquired from the two methods showed a correlation of 0.91 and 0.98, respectively. Results showed that hypocotyl images obtained with the automatic process can replace the ones with the SmartRoot process. Macro in ImageJ could be recorded, and images could be batch processed, reducing time for analysis.

**Keywords:** Image processing, SmartRoot, hypocotyl, length, diameter

# INFORMATION SYSTEMS SUPPORTING PLANT PRODUCTION

**Nenad Bestvina**

Spin d.o.o. Osijek, Županijska 15, 31000 Osijek, Croatia (nenad@spin.hr)

## Abstract

Monitoring efficiency in agricultural production, in order to ensure a timely reaction to observed problems, becomes necessary to ensure competitiveness. Today's software tools make it possible to receive all the necessary information just in time and provide timely information that increases the efficiency of agricultural production.

Efficiency of production, in order to increase competitiveness and awareness of the importance of demonstrable production of healthy food in order to secure a market position, in the last few years have significantly changed the way of monitoring business processes in plant production.

We are witnessing an increasing number of various norms, legal provisions and certificates, in which there is one common denominator - more and more detailed, precise and long-term planning, and more and more detailed and precise records of the daily production process.

On the other hand, with all these additional records, we increase the rationalization of production, which is in direct correlation with greater preservation of the natural environment during production.

In response to these processes, Spin offered through the Jupiter software a set of functionalities for managing processes in plant production, which are an integral part of a complete ERP solution.

With these solutions, we have enabled rational production, which increases efficiency, reduces production costs and, with the application of other ecological measures in agronomy, raises the level of preservation of the natural environment during production.

Integration with GPS systems for monitoring agricultural machinery achieves a fully automated performance record.

GEO Portal is a graphic information system that visually displays data related to the condition of crops, works and yields, facilitates the timely recognition of the need for additional activity.

After the finished production, the calculation of the actual cost price, and thus the profitability of the production, becomes a challenge, if all business data and processes are not mutually integrated.

On the other hand, with structured data collected by the described methods, the cost price calculation becomes simpler, more accurate and faster.

Structured analytical data related to agricultural production is the basis for timely detection of inefficient procedures in agricultural production, which ultimately affects the market position of the company.

**Keywords:** plant production, production optimization, Jupiter software



# IMAGE-PROCESSING METHOD FOR APPLE RECOGNITION AND ROBOTIC MANIPULATION

Luka Šumanovac<sup>1</sup>, Petra Pejić<sup>2</sup>

<sup>1</sup> Master study Digital agriculture, Josip Juraj Strossmayer University of Osijek, Faculty of Agrobiotechnical Sciences Osijek, Vladimira Preloga 1, 31000 Osijek, Croatia (lsuman@fazos.hr)

<sup>2</sup> Josip Juraj Strossmayer University of Osijek, Faculty of Electrical Engineering, Computer Science and Information Technology Osijek, Kneza Trpimira 2B, 31000 Osijek, Croatia

## Abstract

The application of image processing and robotics in agriculture can help reduce manual labor in fruit harvesting and sorting. In this paper, an image processing-based system consisting of real robotic arm, an RGB-D camera, and a YOLO v4-based image processing algorithm for detecting and sorting apple is proposed. The proposed system takes a 3D image of apples in the real world, detects the apples in the RGB image, determines their size in depth image, and sorts them accordingly.

**Table 1: Apples detection results**

	Without occlusion	With occlusion	Hands occluding
Number of images	46	11	9
Total number of apples	536	206	131
Precision [%]	97.54	94.16	94.11
Recall [%]	96.26	54.85	85.49
F1-score [%]	96.89	69.32	89.59

**Table 2: Mean deviation in measuring apple diameter**

Total number of apples	19
$\mu$ [mm]	4.3

The proposed algorithm performs best in scenarios without occlusion (Table 1). However, the algorithm detects apples with precision higher than 94 % in all scenarios. Results from size determination experiments are given in Table 2. Mean standard deviation,  $\mu$ , is computed as mean deviation between real measurements and measurements obtained by the proposed vision algorithm. In practice, this means that

the robot would correctly detect, pick, and sort the apples. By picking one apple at a time from the pile, the number of apples would decrease and there would be less occlusion. This means that the robot would probably work very efficiently in the real world. Determining size is important for two things. First, sellers expect apples to be about the same size for sale. Second, an incorrect size determination may cause the robot to smash an apple if the predicted size is too small, or to fail to grasp it if the predicted size is too large. An error in size prediction of a few millimeters would not affect either of the above problems. Overall, the results of the proposed approach justify the use of vision-based robots in apples detection and sorting tasks. In future work, some adjustments to the prediction thresholds could be considered. Also, outdoor RGB-D images should be acquired to test the application of the depth sensor in even more realistic scenarios. Finally, sorting experiments should be conducted where apples are picked and placed by a robot.

**Keywords:** apple, machine vision in agriculture, robot, YOLO v4

## Acknowledgement

This work was supported by the Huawei „Seeds For The Future Scholarship Programm“

# RELIABILITY OF SOIL MOISTURE MEASUREMENT AS A FACTOR DETERMINING THE EFFECTIVENESS OF PRECISION AGRICULTURE

**Lech Gałęzewski<sup>1</sup>, Edward Wilczewski<sup>1</sup>, Marek Kościński<sup>2</sup>, Iwona Jaskulska<sup>1</sup>, Jacek Majcher<sup>3</sup>, Andrzej Wilczek<sup>3</sup>**

<sup>1</sup> Bydgoszcz University of Science and Technology, Faculty of Agriculture and Biotechnology, 7 Prof. S. Kaliskiego St., 85-796 Bydgoszcz, Poland (lech.galezewski@pbs.edu.pl)

<sup>2</sup> National Food Industry Group, 40 Kraszewskiego St., 87-100 Toruń, Poland

<sup>3</sup> Institute of Agrophysics, Polish Academy of Sciences, Doświadczalna 4, 20-290 Lublin, Poland

## Abstract

There is no question that only precision farming allows for the rationalization of plant production. Optimization of agricultural technology, according to the variability of the environment, is the base of this system. For field plant production, this optimization at the moment means adjustment of sowing, fertilization and plant protection parameters. However, it is the water content in the soil that determines virtually all of its physical, biochemical and microbial activity. Water availability is often more important than other agricultural factors. Precise application of individual elements of agricultural technology must therefore consider the current availability of water for plants in every part of the field. Because of these relationships, the aim of the research was to evaluate the currently used methods of soil moisture measurement in terms of their precision and usefulness in optimizing basic agricultural factors.

The literature was analyzed in terms of the selectivity of soil moisture measurement methods in relation to biological water retention. The TDR method (three probes with different sensitivity zones) and the gravimetric method were physically tested in this regard. Soil moisture variability at the microscale (resolution of 100-400 cm<sup>2</sup>) was also tested.

It was found that a significant problem in the determination of soil moisture is the correct interpretation of the results. There is no explanation in the scientific literature on whether soil moisture determined by various methods includes only water contained in its abiotic part or also water contained in living organisms.

Under soil moisture conditions of 3-5% (vv), the measurement error resulting from the presence of rapeseed and rye roots was estimated at 33.5 and 45.4%.

In addition, it was found that the range of soil moisture on the surface of 1 m<sup>2</sup> can reach even 15.2% (vv).

**Conclusions:** For the purpose of precision farming, it is necessary to develop appropriate methods to monitor soil moisture throughout the growing season. Due to the low measurement accuracy, remote sensing methods are not a sufficient basis for making the right decisions regarding the use of production resources and must be calibrated with in situ measurements. Calibration methods may be burdened with a very large error resulting from the biological retention of the soil. Probes used to calibrate remote sensing methods should have a large measurement zone to minimize microscale soil variability.

**Keywords:** biological water retention, soil moisture, microscale variability

# ANDROID APPLICATION FOR ORGANIZING PLANT BREEDING PROGRAMS

Karolina Kajan<sup>1</sup>, Vlatko Galic<sup>2</sup>

<sup>1</sup> Master study Digital agriculture, Josip Juraj Strossmayer University of Osijek, Faculty of Agrobiotechnical Sciences Osijek, Vladimira Preloga 1, 31000 Osijek, Croatia (kkajan@fazos.hr)

<sup>2</sup> Agricultural Institute Osijek, Južno Predgrađe 6, 31000 Osijek, Croatia

## Abstract

Plant breeding uses principles from various sciences to improve the genetic potential of plants. The process combines parent plants to produce the next generation with the best traits. Breeders improve plants by selecting those with the greatest potential based on performance data, pedigrees, and more complex genetic information. Creating plant breeding programs requires detailed planning and knowledge of genetics, plant breeding techniques, and others. Creating a platform where the information about the plant breeding program is stored and managed is the main topic of this paper. In this paper, a mobile application has been developed to improve the organization and productivity of a plant breeding program. For the development of the application described in this paper, Kotlin was used. Kotlin is a general-purpose, free, open-source programming language, often considered the successor to Java. Kotlin is most commonly used for native android application development.

It has object-oriented principles for software support development, the ability to use Android persistence libraries such as Koin dependency injection library, and what is the right structure of mobile application based on MVVM structural pattern is also covered, Firebase as a Backend-as-a-Service (BaaS) from which the Firebase authentication and database was used. and ability to work with multithreaded processes.

The application brings a simpler approach to giving and receiving information to the onfield workers and the person in charge of the plant breeding program. It gives the possibility of easier communication, from which column to which row to pollinate and to what type of pollination is required.

In conclusion, the application is a platform for the organization and management of plant breeding programs. Improvements and upgrades of the application are inevitable. It lacks the possibility for the breeder to upload its own database with the pedigree of the bred crop due to data confidentiality. The application

has not yet been tested in the field, nevertheless, its utilization will greatly facilitate plant breeding programs.

**Keywords:** plant breeding, application, organization, Kotlin

## Acknowledgement

This work was supported by the Huawei „Seeds For The Future Scholarship Programm“.

# SUITABILITY AND SUFFICIENCY OF DATA OBTAINED BY UAV FOR VARIABLE TOPDRESSING OF CROPS

Davor Bilić<sup>1</sup>, Zdenko Lončarić<sup>2</sup>

<sup>1</sup> Master study Digital agriculture, Josip Juraj Strossmayer University of Osijek, Faculty of Agrobiotechnical Sciences Osijek, Vladimira Preloga 1, 31000 Osijek, Croatia (dabilic@fazos.hr)

<sup>2</sup> Josip Juraj Strossmayer University of Osijek, Faculty of Agrobiotechnical Sciences Osijek, Vladimira Preloga 1, 31000 Osijek, Croatia

## Abstract

A wide selection of different sizes and types of unmanned aerial vehicles (UAVs), like single-rotor or helicopter, multi-rotor aircraft and aerodynamic aircraft, can be used in agriculture. The research paper presents the data obtained from an unmanned aerial vehicle used to record fields (winter wheat, barley, maize) for precise crop topdressing. Agricultural land data recording, data processing and analysis of the recorded material were performed using a SenseFly eBee + UAV equipped with an S.O.D.A photogrammetry camera, a Sequoia multi-spectral camera and available software. The possibility of UAVs, which can fly and/or hover over a certain area and take high-resolution digital photos, is particularly significant for real time data collecting. There can be used a very large number of digital photos of a narrow area at a negligible cost compared to satellite images. Of course, the photos are geo-positioned with GPS, which enables their direct processing and analysis with GIS tools. For the accurate analysis of aerial photographs of crops or plantations, NDVI (normalized vegetation index) is usually applied, which requires photographs of the same area in the visible red (R) and near-infrared (NIR) ranges. The ratio  $(NIR-R)/(NIR+R)$  is in the range from 0 to 1 and therefore very suitable for analyzing the crops condition. NDVI is based on the combination of absorption in the red spectrum range and reflection near-infrared spectrum range (part not absorbed by plant photosynthetic pigments). The results of the research and analysis of the collected data proved great potential in the analysis of the effectiveness of the implemented management practices (sowing, nitrogen fertilization and crop protection), but also in making decisions about the current need to implement the other crop management practice (top dressing, pesticide application). Significant differences in NDVI on the same field were found, which enable the optimization of top dressing based on the actual status of crops. The resolution of the collected data is suitable

for the application of variable doses in top dressing. However, it is necessary to calibrate the data for individual crops so that the range of variable fertilization is harmonized with the decision-making model (DSS) in the optimization of fertilization. Therefore, it is necessary to validate the range of variable fertilization, which is not good enough if it was made only on the basis of data collected by UAVs. It would be useful to include data of appropriate resolution on relevant soil properties (soil pH, SOM, nutrient content, texture data) for the DSS and in the validation procedure.

**Keywords:** unmanned aerial vehicle, multispectral camera, NDVI, decision-making model, validation

## Acknowledgement

This work was supported by the Huawei „Seeds For The Future Scholarship Programm“.

# WEED CONTROL USING DRONES AND ROBOTS

Domagoj Grgić<sup>1</sup>, Marija Ravlić<sup>2</sup>

<sup>1</sup> Master study Digital agriculture, Josip Juraj Strossmayer University of Osijek, Faculty of Agrobiotechnical Sciences Osijek, Vladimira Preloga 1, 31000 Osijek, Croatia (dgrgic@fazos.hr)

<sup>2</sup> Josip Juraj Strossmayer University of Osijek, Faculty of Agrobiotechnical Sciences Osijek, V. Preloga 1, Croatia

## Abstract

Weeds are unwanted plants that compete with crops for space, water, light and nutrients and may cause reductions of yield and increase the cost of crop production. Modern agriculture relies on synthetic herbicides as a fast, simple and effective weed control measure. However, their excessive and improper use can cause a series of negative consequences, such as the occurrence of resistant weed populations, herbicide residues in the food chain, and environmental pollution with adverse effects on human and animal health. In order to minimize negative impact of herbicides and fit in strategies of reducing their use, adoption of precision agriculture (e.g., UAVs, remote sensing, robots, machine learning, deep learning, AI, computer vision etc.) in weed control are essential. Precision agriculture aims to establish systems that optimize resource input while maintaining high yields. Currently, uniform application of herbicides across the whole field, regardless of weed density and distribution, is typically conducted, although weeds are rarely evenly distributed and often grow in patches. The site-specific weed management (SSWM) implies application of herbicides or other direct weed control methods only to areas where weed density is above the economic weed threshold. The crucial step in SSWM is the collection of information on weed species composition, density and distribution in the field which enables application of weed control treatments at the right time, intensity and locations. UAVs equipped with different types of sensors (RGB, multispectral and hyperspectral cameras) are used for fast and accurate image acquisition which are afterwards analyzed to generate weed distribution maps. Mapping weeds at early growth stages enables for appropriate herbicide and rates selection, while pre-harvest weed mapping allows control of perennial weeds in following years or detection of herbicide resistant weeds. Weed maps are subsequently used for precise herbicide application to areas with high weed density (patch spraying) or individual plants (spot spraying). Ground sensing on the other hand enables real-time weed detection, recognition and precise spot spraying. Prototypes of

weeding robots that automatically detect and identify weeds and apply small or micro-doses of herbicides are being developed. Beside selective herbicide application, robotic weed control systems that use mechanical weed removal (camera-guided inter- and intra-row weeding), flaming, laser and hot water are utilized. Their application is of great value in case of limited use of herbicides (e.g., organic agriculture), ban on active ingredients and lack of registered and effective plant protection products for specialty crops. Successful SSWM was reported for various crops, from cereals, row crops, vegetables, to permanent stands, with herbicide savings up to 90% without yield reductions compared to conventional application. Integrated Weed Management (IWM) with new tools provides environmental and economic benefits, biodiversity preservation and sustainable agriculture, although precise tools integration and implementation still poses a great challenge in commercial farming systems.

**Keywords:** UAV, AI, robots, sustainability, site-specific weed management.

## Acknowledgement

This work was supported by the Huawei „Seeds For The Future Scholarship Programm“.

## Section 3

---

# Decision support systems and models in digital agriculture



# DATASET OF AN APPLE ORCHARD FOR OBJECT DETECTION

**Ana Marija Antolković, Martina Skendrović Babojelić, Rea Vrtodušić, Mihaela Šatvar Vrbanić, Marko Petek, Antonio Viduka, Tomislav Karažija, Goran Fruk**

University of Zagreb, Faculty of Agriculture, Svetošimunska cesta 25, 10000 Zagreb, Croatia (marko.petek@agr.hr)

## Abstract

Computer vision has enabled the optimization of fruit production by providing an early alert to the farmer. Several automated crop monitoring systems have been proposed in the field of crop phenotyping, yield monitoring, and crop protection at various growth stages. Automated computer vision systems rely on large data sets to train, test, and compare diverse approaches. Classification of different parts of apple tree fruit presents significant challenges due to interclass similarities because of the resemblance of some parts in the growth stages of apples. The objective of this research was to explore the possibility of detection of different apple tree parts during phenophases in an apple orchard using image analysis. The research was conducted in 2021 and 2022 in five commercial apple orchards around Zagreb in Croatia. About 5 000 images were taken with an RGB camera at different growth stages of the apple orchard. Images in the dataset were manually annotated in Labellmg software using bounding boxes and presented in PascalVOC format. Appels were annotated in different phenophases like a generative spur, flower cluster, healthy juvenile leaf, and various stages of the development of fruit. The EfficientDet architecture has been used as an object detection algorithm. Experimental results on a challenging dataset demonstrate that the average precision percentage of the generative spur, flower cluster, fruit frost, and deformed fruit was 51%, 63%, 38%, and 53%. Apple fruits were also classified by color, so we had classes for red and green apples whose average precision percentages for detection were 63% and 71%, respectively. The results indicate that various apple classes can be developed more effectively for detection, which can help the robot to decide the alert strategy (e.g., flower or fruit damage and yield planning) as well as to avoid potential damage by the branches and trellis wires.

**Keywords:** annotation, average precision, classes, computer vision, fruit

## Acknowledgment

The results presented in the paper are output from research project KK.01.2.1.02.0290 „AgriArt comprehensive control system in the field of precision agriculture“.



# THE USE OF ARTIFICIAL NEURAL NETWORKS AS A TOOL FOR DETECTION OF LEPIDOPTERAN APPLE PESTS

Dana Čirjak<sup>1</sup>, Ivan Aleksi<sup>2</sup>, Ivana Miklečić<sup>1</sup>, Darija Lemić<sup>1</sup>, Tomislav Kos<sup>3</sup>,  
Ivana Pajač Živković<sup>1</sup>

<sup>1</sup> University of Zagreb Faculty of Agriculture, Department of Agricultural Zoology, Svetošimunska cesta 25, 10 000 Zagreb, Croatia (dcirjak@agr.hr)

<sup>2</sup> Josip Juraj Strossmayer University of Osijek, Faculty of Electrical Engineering, Computer Science and Information Technology, Kneza Trpimira 2B, 31 000 Osijek, Croatia

<sup>3</sup> University of Zadar, Department of Ecology, Agriculture and Aquaculture, Trg kneza Višeslava 9, 23 000 Zadar, Croatia

## Abstract

One of the most important apple pests are insects from the order of butterflies (Lepidoptera) - the codling moth (*Cydia pomonella* (Linnaeus, 1758)), whose larvae feed on apple fruit, making it unusable for the market, and the pear leaf blister moth (*Leucoptera maifoliella* (O. Costa, 1836)), whose larvae develop in apple leaves. Classical pest monitoring methods are unreliable and time-consuming, resulting in greater damage to apple production. The use of artificial neural networks (ANN) has recently shown great potential for pest monitoring. Therefore, the aim of this paper is to present ANNs as a pest detection tool that can be used for automatic monitoring of Lepidoptera apple pests (Figure 1).

Looking at the examples from the literature where ANNs are used for apple pest monitoring and comparing their accuracy, it can be seen that all effective models for codling moth detection have an accuracy of over 90% in most cases compared to manual counts by human experts. The model for pear leaf blister moth is still pending, but since it belongs to the same order as codling moth (Lepidoptera), the model accuracy should also be high. In addition, ANNs have been used to detect damage to leaves caused by the pear leaf blister moth and also achieved high accuracy.

Further development of ANNs for detection and monitoring of important apple pests is certain. Thus, this study reveals an unexplored potential for the use of ANNs in monitoring apple pests from the order Lepidoptera. Therefore, this work advocates more efficient and rapid monitoring that allows for targeted and effective pest control without unnecessary insecticide treatments and thus without negative agricultural impacts on the environment and human health.

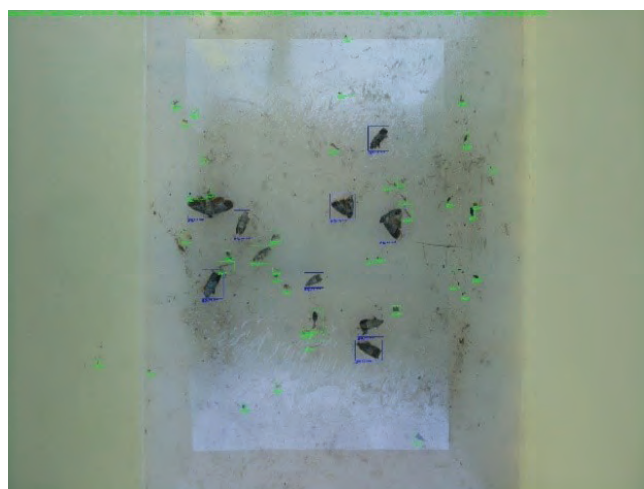

Figure 1. Results of pest detection using ANN

**Keywords:** ANNs, *Cydia pomonella* (Linnaeus, 1758), *Leucoptera maifoliella* (O. Costa, 1836), pest monitoring, smart agriculture

## Acknowledgement

The presented paper is an output from research project KK.01.2.1.02.0290.

# DETECTION AND EVALUATION OF ENVIRONMENTAL STRESS IN WINTER WHEAT USING PROXIMAL SENSING METHODS

Sandra Skendžić<sup>1</sup>, Monika Zovko<sup>1</sup>, Vinko Lešić<sup>2</sup>, Marko Maričević<sup>3</sup>, Ivana Pajač Živković<sup>1</sup>, Darija Lemić<sup>1</sup>

<sup>1</sup> University of Zagreb, Faculty of Agriculture, Svetošimunska cesta 25, 10000 Zagreb, Croatia (sskendzic@agr.hr)

<sup>2</sup> Innovation Centre Nikola Tesla, Unska 3, 10000 Zagreb, Croatia

<sup>3</sup> Bc Institut d.d., Rugvica, Dugoselska 7, Dugo Selo, Croatia

## Abstract

Climate change has significant impacts on winter wheat (*Triticum aestivum* L.) production through the occurrence of various environmental stress parameters. In this sense, drought stress and pest infestation, especially in sensitive phenophases, are the main threats to wheat production stability and final yield loss. These stress factors lead to changes in the physiological response of winter wheat plants and can be monitored by various multi- and hyperspectral remote sensing systems (satellite, airborne, and proximal). One of the best known and most accurate methods for monitoring plant stress is proximal remote sensing. As plant responses to environmental stress are numerous and complex, their physiological effects affect the signal in different regions of the electromagnetic spectrum, such as visible (VIS), near infrared (NIR), and shortwave infrared (SWIR). Through their feeding, pests cause changes in plant pigments and cell structure, resulting in variations in VIS and NIR reflectance, while plant water content has been associated with variations in certain bands in the SWIR region of the spectrum.

The availability of hyperspectral data has led to the definition of vegetation indices (VI), which, by combining the values of different regions of spectrum with plant (or soil) characteristics, can quantify many agronomic variables and estimate the severity of plant stress. In addition to VI, the total spectral signature (reflectance) or its derivatives and principal components (PC) are often used to assess plant condition. Chemometric (multivariate) and machine learning models are commonly used to determine the relationship between groundtruth parameters (water content in plants/soil, level of pest infestation, etc.) and leaf/canopy spectral characteristics. These include principal component analysis (PCA), partial least squares regression (PLSR) and principal component regression (PCR), artificial neural networks (ANN) and support vector machines (SVM).

**Keywords:** climate change, winter wheat, reflectance, remote sensing, environmental stress

## Acknowledgement

The results presented in the paper are an output from research project Advanced and predictive agriculture for resilience to climate change (AgroSPARC) (KK.05.1.1.02.0031) funded by European Regional Development Fund.



Picture 1. Workflow for detection and evaluation of environmental stress in crops using proximal sensing methods for precise agricultural management decisions

# SOYBEAN YIELD PREDICTION BASED ON IRRIGATION AND NITROGEN FERTILIZATION USING MACHINE LEARNING

Daria Galić Subašić, Mladen Jurišić, Dorijan Radočaj, Ivan Plaščak, Irena Rapčan

Josip Juraj Strossmayer University of Osijek, Faculty of Agrobiotechnical Sciences Osijek, Vladimira Preloga 1, 31000 Osijek, Croatia (dgsubasic@fazos.hr)

## Abstract

The production of soybean (*Glycine max* L. Merr.) has increased significantly in recent years and represents one of the most important highly profitable legumes. It is cultivated throughout the world, due to its high content of protein, oil and useful phytochemicals. With the use of soybean in the livestock feeding, the processing industry and human nutrition, the need to increase the quality of soybean yield emerged. The sustainability of soybean production is seriously threatened by poor fertilization management and drought in critical stages of development, which can significantly reduce its yield. Agricultural water deficit occurs in case of insufficient amount of precipitation and water content in the soil caused by climate change. Therefore, in conditions of water supply exclusively through precipitation, the lack of water is one of the most widespread factors limiting crop production.

The field research was conducted at the Agricultural Institute Osijek during 2015. The effect of irrigation and nitrogen fertilization on the yield and quality of four soybean varieties was investigated. The included varieties were Lucija (00), Vita (0), Ika (0-I) and Tena (0-I). Irrigation was carried out in three treatments: control treatment (natural conditions, only water from precipitation); rational irrigation (water content in the soil was maintained from 60% to 100% soil water retention capacity); and abundant irrigation (water content in the soil was maintained from 80% to 100% soil water retention capacity). The fertilization with mineral nitrogen was performed in three variants as well, including control variant without nitrogen fertilization, fertilization with 100 kg N ha<sup>-1</sup> and fertilization with 200 kg N ha<sup>-1</sup>.

Multiple linear regression (MLR) represented a conventional prediction approach and served as the baseline for evaluating the efficiency of machine learning algorithms for the prediction of soybean yield according to irrigation and nitrogen fertilization. Ran-

dom forest (RF), support vector machine (SVM) and Extreme gradient boost (XGB) were selected as the representative machine learning algorithms from the ensemble decision trees and support vector machine supervised regression groups. Their performance was evaluated using the coefficient of determination (R<sup>2</sup>), root mean square error (RMSE) and mean absolute error (MAE), as presented in Table 1.

**Table 1. The accuracy assessment of soybean yield prediction.**

Algorithm	R <sup>2</sup>	RMSE (kg)	MAE (kg)
MLR	0.589	398.2	330.2
RF	0.646	369.8	316.0
SVM	0.575	404.7	336.3
XGB	0.645	370.5	316.4

RF and XGB outperformed the conventional MLR according to all three metrics, producing 9.7% and 9.5% higher R<sup>2</sup> than baseline. Their potential could be further exploited for more efficient soybean management by including additional independent variables without impairing computational efficiency of evaluated algorithms.

**Keywords:** crop management, regression algorithms, random forest, extreme gradient boost, decision trees

# A MODEL FOR CALCULATING THE TECHNICAL POTENTIAL OF BIOMASS FROM AGRICULTURE

**Ružica Lončarić, Sanja Jelić Milković, Tihana Sudarić, Zdenko Lončarić**

Josip Juraj Strossmayer University of Osijek, Faculty of Agrobiotechnical Sciences Osijek, Vladimira Preloga 1, 31000 Osijek, Croatia (ruzica.loncaric@fazos.hr)

## Abstract

Biomass from agriculture represents a significant resource for the production of compost, substrate and animal feed, as well as other products with higher added value in the food and pharmaceutical industry. The paper presents a model for calculating biomass from agriculture for certain agricultural crops. The term technical potential is used to calculate the amount of biomass. The sources of data on areas (ha), production (t) and yields (t ha<sup>-1</sup>) of the most important field crops are data from the Agency for Payments in Agriculture, Fisheries and Rural Development and data from the National Bureau of Statistics. To calculate the technical potential of crop residues, the RenewIslands ADEG methodology was used according to previously published results. The starting point for calculating the technical potential is the production of agricultural crops in a certain area (area and yield). The amount of production is multiplied by the harvest index, which is a coefficient ranging from 0.13 (sugar beet) to 3 (sunflower) to obtain the amount of agricultural biomass that remains after harvesting the crop, called total biomass potential. However, the whole amounts of agricultural residues cannot be used, because a part must be left on the field for incorporation in soil due to increasing humus content (all cereals and industrial crops), a part would be used for animal husbandry (wheat and barley), and a part is simple harvest losses. The technical potential of biomass is calculated by deducting from the total potential the amounts required for incorporation in soil, animal husbandry and harvest losses. The model presents a model for calculating the technical potential of biomass for cereals and industrial crops. The model represents a contribution to the calculation of agricultural residues in some agricultural area in order to understand the potential for further use of these raw materials for the production of value-added products (compost, substrates, animal feed, pharmaceutical and food industry products).

**Keywords:** cereals, field crops, harvest index, industrial crops, residues

## Acknowledgement

This work is supported by the project KK.01.1.1.04.0052: "Innovative production of organic fertilizers and substrates for growing seedlings (INOPROFS)" co-financed by the European Union from the European Regional Development Fund within the Operational programme Competitiveness and Cohesion 2014–2020 of the Republic of Croatia.

# IN SILICO PESTICIDE DISCOVERY – A COMPUTATIONAL SCREENING OF COUMARINYL 1,2,4-TRIAZOLES

Maja Karnas, Vesna Rastija, Domagoj Šubarić

Josip Juraj Strossmayer University of Osijek, Faculty of Agrobiotechnical Sciences Osijek, Vladimira Preloga 1, 31000 Osijek, Croatia (mkarnas@fazos.hr)

## Abstract

The development of new pesticides, from the design and synthesis of active compounds to their commercialization, is an expensive and time-consuming process, requiring research on multiple biological and environmental effects. Computer-aided molecular design techniques are nowadays broadly applied in this area, saving both research time and economic costs of biological tests.

The aim of this study was to perform a computational screening of novel coumarinyl 1,2,4-triazole compounds (Fig. 1) in order to investigate their viability as new active compounds for pesticides. Their pesticide-likeness was estimated according to the rules defined by Hao et al., wherein six molecular descriptors were calculated for each compound and compared to the threshold values. Furthermore, as both, coumarins and 1,2,4-triazole derivatives are proven to exhibit antifungal activity, their hybrid compounds could show similar activity. Someazole fungicides act as inhibitors of the growth of fungi in already invaded plants. Possible targets for research on the mechanism of action of such antifungal agents are enzymes responsible for fungal growth. Therefore, a molecular docking analysis was performed to evaluate the type of binding between the ligand and the enzyme sterol 14  $\alpha$ -demethylase. Inhibition potentials of the screened compounds were ranked by combining the pharmacological interactions and energy-based scoring function: Total Energy (kcal mol<sup>-1</sup>) = vdW + Hbond + Elec.

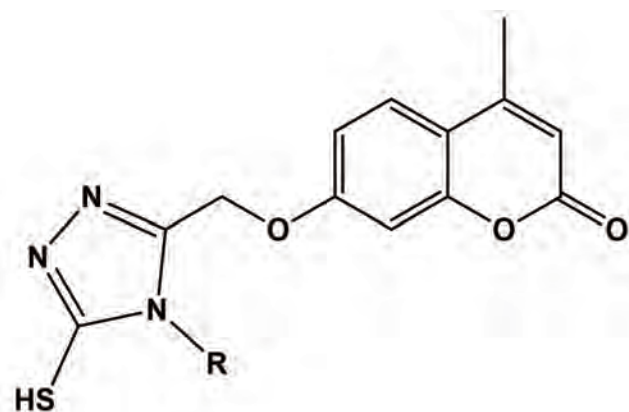

Figure 1. General structure of coumarinyl 1,2,4-triazoles

Calculated values of the molecular descriptors showed that all of the screened compounds satisfied pesticide-likeness criteria. Molecular docking analysis revealed the possibility of tested compounds to form complexes with catalytic domain of demethylase. These results are in accordance with the hypothesis about coumarinyl 1,2,4-triazoles as viable antifungal agents, and should be further confirmed by in vitro analysis.

**Keywords:** coumarinyl 1,2,4-triazole, pesticide-likeness, molecular docking, antifungal activity

## Acknowledgement

The results presented in the paper are an output from research projects of Croatian Science Foundation, under the project "Green Technologies in Synthesis of Heterocyclic Compounds" (UIP-2017-05-6593).

# OPTIMIZING SOIL MANAGEMENT BY MODELING THE AVAILABILITY OF IRON IN AGRICULTURAL SOILS

Milena Andrišić<sup>1</sup>, Hrvoje Hefer<sup>1</sup>, Daniel Rašić<sup>1</sup>, Ivana Zegnal<sup>1</sup>, Domagoj Mikulić<sup>1</sup>, Zdenko Lončarić<sup>2</sup>

<sup>1</sup> Croatian Agency for Agriculture and Food, Vinkovačka cesta 63c, 31000 Osijek, Croatia

<sup>2</sup> Josip Juraj Strossmayer University of Osijek, Faculty of Agrobiotechnical Sciences Osijek, Vladimira Preloga 1, 31000 Osijek, Croatia (zloncaric@fazos.hr)

## Abstract

Intensive agricultural production, without proper management, will probably cause soil degradation. Therefore, monitoring soil quality in agricultural regions is essential for soil protection. Analytical results of soil properties can be successfully combined with mathematical and/or computer models to predict values of soil indicators that have not been analytically determined. In doing so, it is very important to determine as accurately as possible which properties determine the intensity of a certain soil indicator to the greatest extent. Iron is an essential element whose availability in the soil depends significantly on the total concentration of Fe in the soil, soil pH value and SOM content, and the lack of plant available Fe can limit production on poor, especially carbonate soils. The aim of this research was to determine the possibility of using available data to predict Fe availability with regression models. The regression model was created using a data set with the results of analysis of Fe concentration in more than two hundred soil samples (total Fe extracted with aqua regia in the range 2-3.9% and plant available Fe in the range 10-45 mg kg<sup>-1</sup>). The model was used to predict the available Fe based on the analysed soil properties (pHH<sub>2</sub>O, pHKCl and SOM content) of 1,000 soil samples with the total analysed production area 5,194 ha.

Modeling available Fe on a new set with 1,000 soil samples predicted that the low concentration of available Fe will be only on 1.83 % of analysed areas, which is just 95 ha. The moderate range of plant available Fe was predicted at 245 ha (4,72 % area). High level of Fe availability was predicted at 93,45 % area, i.e. on 4.854 ha. The model predicts a very small proportion of samples with a low Fe available to the plant, which leads to the assumption of low accuracy of the model, even though SOM and two pH values were used.

If that's the case, a data set with basic soil indicators is not sufficient to predict Fe availability.

The demonstrated use of the model indicates that modeling can be effectively used to predict certain soil indicators without actual laboratory analysis, saving time and resources. This can be especially significant in cases of a large number of soil samples from different and heterogeneous production areas. However, the accuracy of the model must be validated, which is possible only by validation with a reasonably selected new set of samples and analytical results. Thereby, it is more likely that analyzes of additional soil properties (like percentage of clay particles, total amount and different fractions of Fe) will be required in addition to the basic soil analyses (pHH<sub>2</sub>O, pHKCl and SOM content).

**Keywords:** availability modeling, regression model, EDTA, Fe

## Acknowledgement

The results presented in the paper was the result of research within the project KK.05.1.1.02.0018 "AGROEKOTEH - Optimizacija gospodarstva tlo i prilagodba agroekosustava i agrotehničkih mjera klimatskim promjenama" funded by the European Union from the European Regional Development Fund.

# MODELING OF ZINC AVAILABILITY IN THE SOILS OF EASTERN CROATIA

Hrvoje Hefer<sup>1</sup>, Milena Andrišić<sup>1</sup>, Ivana Zegnal<sup>1</sup>, Daniel Rašić<sup>1</sup>, Domagoj Mikulić<sup>1</sup>, Zdenko Lončarić<sup>2</sup>

<sup>1</sup> Croatian Agency for Agriculture and Food, Vinkovačka cesta 63c, 31000 Osijek, Croatia

<sup>2</sup> Josip Juraj Strossmayer University of Osijek, Faculty of Agrobiotechnical Sciences Osijek, Vladimira Preloga 1, 31000 Osijek, Croatia (zdenko.loncaric@fazos.hr)

## Abstract

The role of microelements and their availability in soils is often overlooked in agricultural practice. The reasons lie in two facts that are closely related to soil properties and crop needs. First, the total content of microelements in soils is significantly higher than the small amount that plants need. Second, the insufficient availability of microelements is much less often a limiting factor in crop cultivation than the lack of water, nitrogen and other macro nutrients. However, the fact that it is not the total amount that is important, but the fraction of microelements available to plants has been neglected. At the same time, the available fraction of microelements is closely related to the basic soil properties (soil pH, organic matter content, soil texture) and it is expected that this dependence can be described mathematically. The only question is, which property of the soil should be used sufficiently to accurately predict the availability of individual microelements. Zinc (Zn) is one of the microelements whose availability in soil is closely related to pH value, SOM content and soil texture. The average total content of zinc in the soil is in the range of 5-20 mg/kg, but can be significantly higher. The availability of zinc is higher in acidic soils, but there is also a greater risk of leaching, and Zn deficiency most often occurs on heavy, clayey soils. Based on the above assumptions, the aim of this paper was to determine the accuracy of regression models for predicting plant available fractions of Zn in the soil. The regression model was created based on the results of the basic soil analysis (pH and SOM) and total Zn content and available Zn fractions in more than two hundred soil samples (total Zn extracted with aqua regia was in the range 40-115 mg kg<sup>-1</sup>; available Zn extracted with EDTA solution was in the range 0.4-8 mg kg<sup>-1</sup>). The new set of 1,000 soil samples with results of basic soil properties (pHH<sub>2</sub>O, pHKCl and SOM) was used to predict plant available Zn fraction in soil. The average 1.59 mg kg<sup>-1</sup> of Zn available fraction was predicted, what is in the

range of medium soil supply with available Zn. Insufficient Zn availability (<1.50 mg kg<sup>-1</sup>) was in 463 samples (representing 2,455 ha or 47.26% of analyzed areas), medium availability in 526 samples (for 2,666 ha or 51.33% area) and high Zn availability (>3 mg kg<sup>-1</sup>) in only 11 samples (72 ha, 1.41 % area). Taking into account that the insufficient availability of Zn is predicted on slightly more than 47% of production areas, which can significantly limit agricultural production, it is necessary to validate the model, i.e. determine the accuracy of the predicted Zn availability by lab analysis.

**Keywords:** regression models, total Zn, validation, EDTA extraction, available Zn

## Acknowledgement

The results presented in the paper was the result of research within the project KK.05.1.1.02.0018 "AGRO-EKOTEH - Optimizacija gospodarstva tlo i prilagodba agroekosustava i agrotehničkih mjera klimatskim promjenama" funded by the European Union from the European Regional Development Fund.

# AGRICULTURAL REALITY VS. DATA DENSITY – PARSIMONIOUS APPROACH WITH KERNEL METHODS

**Vlatko Galić, Domagoj Šimić**

Agricultural Institute Osijek, Južno Predgrađe 6, 31000 Osijek, Croatia (vgalic@poljinoh.hr)

## Abstract

Agricultural reality is often underrepresented in statistical and mathematical models. Shifting the agricultural paradigm towards data-driven approaches encourages the data collection, however with unknown data structure and information density. Recently, machine learning methods are emerging as state-of-the-art tools for integration of various data into the models, increasing the model predictive abilities, with tradeoff of reducing the model interpretability. Kernel methods, mapping the data into a different kernel space, thus come in handy for reducing redundancy, while maintaining predictive power. Also, integrating data from various sources enables kernel-based increase in interpretability, facilitating the interpretation of models, as well as model troubleshooting. We designed a prototype of a proximal, field-based multispectral sensor with integrated weather station. The prototype was proven successful in sensing of various important traits. However, the integration of the relevant data to the state of the art plant growth models might be challenging. The possibility of use of the kernel methods and increasing the model information density and interpretability in agricultural systems will be discussed.

**Keywords:** proximal sensing, remote sensing, multispectral, kernel methods

## Acknowledgement

This work is supported by the project “IoT-field: An Ecosystem of Networked Devices and Services for IoT Solutions Applied in Agriculture” co-financed by the European Union from the European Regional Development Fund within the Operational Programme Competitiveness and Cohesion 2014–2020 of the Republic of Croatia.



## Section 4

---

# Digital technologies in agriculture



# DEVELOPMENT OF AN AUTOMATIC BODY CONDITION SCORE SYSTEM FOR DAIRY COWS

**Dragan Solić<sup>1</sup>, Darko Bosnar<sup>2</sup>, Karlo Liović<sup>2</sup>, Vesna Gantner<sup>3</sup>**

<sup>1</sup> Croatian Agency for Agriculture and Food, Vinkovačka cesta 63c, 31000 Osijek, Croatia

<sup>2</sup> InfoDom Ltd., A. Žaje 61/1, 10000 Zagreb, Croatia

<sup>3</sup> Josip Juraj Strossmayer University of Osijek, Faculty of Agrobiotechnical Sciences Osijek, Vladimira Preloga 1, 31000 Osijek, Croatia (vgantner@fazos.hr)

## Abstract

The time in which we produce is characterized by an increasing need for food of animal origin, implying a necessary increase in the number of animals on farms and an increase in productivity per individual animal, and on the other hand, a decreasing availability of the necessary workforce. In these conditions, the methods of precision animal production are imposed as an optimal solution. Dairy cattle breeding is one of the most complex animal productions, where for optimal management it is necessary to ensure the farmer's timely reaction. Furthermore, the cow's body condition as an indicator of body reserves provides information regarding the health and readiness for the production of an individual cow and the entire herd, as well as the method and strategy of feeding. Standard methods for body condition scoring (BCS) require high expertise of the evaluator and are time-consuming. The use of an automatic BCS system would enable daily evaluation and significantly increase objectivity. Therefore, the goal of this research was the development of an automatic BCS system.

During the field part of the research, a depth camera was used to take photos (colour and depth) of dairy cows from above. Furthermore, during the analytical part of the research, the collected colour photos were processed through an AI module that uses CNN Neural Networks to generate the BCS score of an individual cow. Based on the above, a model was refined for evaluating the BCS condition of cows based on colour photos. The result of the initial test showed an accuracy of a maximum of 55% for a set of 89 photos of cows. Considering the above, it is necessary to carry out further field evaluation in order to collect at least 600 photos of cows in order to achieve a more reliable result, i.e. higher accuracy of the evaluation.

**Keywords:** body condition score, dairy cattle, automatic system, neural networks

## Acknowledgement

The results presented in the paper are an output from research project KK.01.2.2.03.0013. CEKOM - Competence Centre for Digital Transformation of the Food Industry in Rural Areas.

# DIGITAL AGRICULTURE IN BEEKEEPING – DEVICE FOR REVEALING THE SWARMING STATE OF A HONEY BEE COLONY

Filip Jaman, Zlatko Puškadija, Marin Kovačić

Josip Juraj Strossmayer University of Osijek, Faculty of Agrobiotechnical Sciences Osijek, Vladimira Preloga 1, 31000 Osijek, Croatia (marin.kovacic@fazos.hr)

## Abstract

Honey bee (*Apis mellifera*) through the pollination have a major impact on the production in agriculture. The use of digital systems in beekeeping can improve the monitoring of individual honey bee colonies and improve the efficiency of beekeeping by bringing it to a higher technological level. By using different digital systems, data could be collected on the apiary level (meteorological data), on a colony level (temperature in the hive, sounds and vibrations, weight of colony ect.) and on the individual level (monitoring of bees on the hive entrance).

The IoT technology has slowly found its way into the beekeeping sector. One of such technological systems helps to reveal the swarming state of a honey bee colony. The swarming is an event during which the queen leaves the hive with a certain number of worker bees and drones. Swarming is a natural way of honey bee reproduction, which the beekeeper tries to reduce to the smallest possible extent because the colony which swarms out will produce small amounts of honey in the forthcoming season. Parameters such as temperature, humidity and weight change during the swarming can be monitored using sensors installed in the hive. The occurrence of swarming may also be determined by the frequency of sounds inside the hive, which is around 400-500 Hz lasting at least 35 minutes.

The example of one of the systems used in Europe is called BeeQ, an automated monitoring system that is installed on hives. The advantage of this system is low energy consumption and low general costs compared to other systems. The sensors collect data which are stored in the "cloud", where data are analyzed and sent to a smart device or laptop owned by the beekeeper. Magnetic sensor on the lid of the automated hive that transmits data to the cloud every time the lid of the hive is opened. A gyroscopic sensor measures the temperature and humidity inside the hive. A

sound sensor records in detail the sound frequency inside the beehive in the ranges from 20 Hz to 2 KHz. Based on the frequencies recorded inside the hive, it is possible to predict the swarming, the attack on the hive by hornets, wasps and other undesirable animals. A weight sensor is placed under the hive. Internal and external temperature and humidity sensors monitor the microclimate of the apiary and hive. Thermal pad placed on the side of the brood regulates the temperature of the hive and reduces the number of Varroa mites. An infrared camera attached to the inside of the beehive is used to monitor the intake of nectar, pollen, the process of brood feeding and even of early detection of diseases. In addition to the listed sensors, the necessary equipment also includes a transponder and a battery. This system works on the principle of collecting data and processing it with the help of algorithms and beekeeper receives a result on his smartphone. The advantage of this kind of system is that the beekeeper receives a notification about the necessary interventions in the apiary at the exact time to prevent swarming.

**Keywords:** *Apis mellifera*, IoT, digital agriculture

# APPLICATION OF ELECTRONIC IDENTIFICATION (EID) IN SMALL RUMINANTS

Željka Klir Šalavardić, Josip Novoselec, Zvonko Antunović

Josip Juraj Strossmayer University of Osijek, Faculty of Agrobiotechnical Sciences Osijek, Vladimira Preloga 1, 31000 Osijek, Croatia (zklir@fazos.hr)

## Abstract

According to EUR-Lex in European Union countries having higher than 600,000 sheep and goats it is obligatory to apply their electronic identification. All sheep and goats need to be identified with two identifiers containing the same unique individual identification number (ID), among which one must be an electronic identifier (EID). Thus, this study aimed to explain an application of electronic identification in small ruminants. Animals need to have EID in order to: 1) protect the health of animals and people from infectious and invasive diseases; 2) monitor the control of domestic animals traffic; 3) monitor the traceability of products of animal origin; 4) enable proper breeding and selection work in sheep and goat farming and 5) accomplish the right to financial support. Individual animal identification provides and maintains animal's individual data, such as ID, parentage, birth date, performance data, history of health and vaccination, and disease control enabling the improvement of farm management. Since 2010 in the Republic of Croatia (606,172 sheep and 71,872 goats registered) sheep and goats need to be identified with ear tag and ruminal bolus, containing microchip, which implies animal radio frequency identification (RFID).

The RFID uses low frequency band (low read range, around 20 cm) which is very safe for animal, and requires low frequency because it can pass through water and animal tissue. The stick reader and handheld with operating system, or panel/static reader are designed for electronic reading, and collecting the individual ID number stored on the EID tag or ruminal bolus. Boluses contain tamper proof features and have high retention. The boluses for small ruminants should be less than 70 g, while specific gravity needs to be higher than 2.5 to provide retention in the rumen. Retention of boluses is higher than retention of ear tag. Electronic devices are highly efficient and could be recommended for sheep and goats. As observed in the available literature, boluses application do not produce any important effect on the body growth parameters and the stomach development, thus it can be considered as a valid method for tracing small ruminants.

**Keywords:** electronic identification, small ruminants, ear tag, ruminal bolus



Figure 1. How application of electronic identification (EID) works in small ruminants

# APPLICATION OF PLF TOOLS FOR MONITORING HEALTH OF DAIRY COWS

Mislav Đidara<sup>1</sup>, Zdenko Ivkić<sup>2</sup>, Matej Brlić<sup>3</sup>, Ivana Prakatur<sup>1</sup>, Martina Pavlič<sup>2</sup>, Marcela Šperanda<sup>1</sup>

<sup>1</sup> Josip Juraj Strossmayer University of Osijek, Faculty of Agrobiotechnical Sciences Osijek, Vladimira Preloga 1, 31000 Osijek, Croatia (mdidara@fazos.hr)

<sup>2</sup> HAPIH, Vinkovačka cesta 63c, 31000 Osijek, Hrvatska

<sup>3</sup> OPG Zlatko Brlić, Kapela Dvor, Kapela dvor 7a

## Abstract

Precision livestock farming (PLF) tools are essential for efficiency of modern livestock production. On-site, non-invasive prediction of animal health is not only necessary for optimization of milk production but also for achieving optimal animal welfare. Mastitis, as an inflammation of milk gland, is one of the major health issues in milk production, and can have dear consequences for animal health, production, longevity and wellbeing. Therefore, development of PLF tools are extensive in this area. The experiment aimed to evaluate a method of automatic on-site determination of milk conductivity (as a predictor of mastitis risk) by correlating its values with somatic cell count from a referent laboratory. Milk from 66 dairy cows was used in the experiment, of which there were 32 cows in the first lactation, 14 in the second, 11 in the third and 9 in the fourth and higher lactations. At the beginning of the experiment, the cows were in lactation for an average of 160 days. Milk samples were taken in three consecutive points with 21 days apart.

Milk samples, since the milking is robotic, were taken out with a special device, which is connected to the milking robot. With this method, risk for sample contamination is reduced to minimum. The samples were sent for milk somatic cell counting (SCC) to the Reference laboratory for milk and dairy products in Križevci, and the analyzes were carried out on Fossomatic 7 (Foss, Denmark). Milk conductivity index (MDI) was determined using a DeLaval VMS™ V300 (DeLaval, Sweden). Descriptive statistics for determined parameters were performed using STATISTICA (TIBCO Software Inc. 2018). The assumption of normality was checked using the Shapiro–Wilk test. Variables were not normally distributed so correlation between SCC and MDI was performed using Spearman nonparametric test. Correlation between SCC and MDI in milk of all samples (199) was significant ( $P < 0.05$ ) moderate and positive (0.424). Correlation between SCC and MDI in milk of cows in first lactation was weak and not significant ( $P > 0.05$ ; 0.165). Correlation for second, third, fourth and higher lactation cows was significant ( $P < 0.05$ ) moderate and positive: 0.562; 0.529 and 0.628 respectively. This proves applicable value of on-site automated determination of milk changes through MDI and its use in mitigation of mastitis. It encourages farmers to stay vigilant in monitoring udder's health and to react quickly to prevent serious consequences for cow's health.

**Keywords:** precision livestock farming (PLF), dairy cows, mastitis, SCC

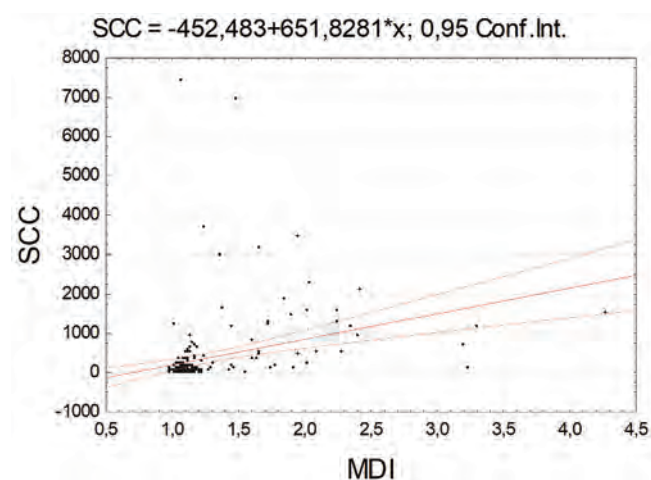

Graph 1. Spearman correlation between SCC and MDI in milk of cows.

# THE APPLICATION OF INFORMATION AND COMMUNICATIONS TECHNOLOGIES IN HORSE BREEDING

**Martina Hasija<sup>1</sup>, Maja Gregić<sup>1</sup>, Tihomir Živić<sup>1</sup>, Tina Bobić<sup>1</sup>, Pero Mijić<sup>1</sup>, Katarina Miljak<sup>2</sup>, Mirjana Baban<sup>1</sup>**

<sup>1</sup> Josip Juraj Strossmayer University of Osijek, Faculty of Agrobiotechnical Sciences Osijek, Vladimira Preloga 1, 31000 Osijek, Croatia (mirjana.baban@fazos.hr)

<sup>2</sup> University of Zagreb, Faculty of Veterinary Medicine, Heinzelova 55, 10000 Zagreb, Croatia

## Abstract

Information and communications technologies (ICTs) are a system of tools and sources that serve to collect, process, and disseminate information. In agriculture and equine breeding, the ICTs are used to match the modern advances in research technology to the application of technologies that agriculture and equine breeding have to offer. Some of the advantages of using the ICTs in agriculture and horse breeding are a detailed and continuous monitoring of animals, monitoring of diseases and treatment, and the access to valuable information that can help the breeders make the best decisions. Various technologies are used in horse breeding, some of which are as follows: 3D horseshoe printing, deployment of robots, and the application of artificial intelligence (AI). The 3D horseshoe printing makes it possible to obtain the custom-made horseshoes individually. Robots, on the other hand, are the automated machines that perform the tasks usually performed by humans. In horse breeding, robots are applied for horse elevators and scanning devices. The purpose of a horse elevator is to carefully elevate the horse while the animal is positioned in a sling by controlling its weight distribution. The elevators thus assist the rehabilitation of equines suffering from the acute injuries and other musculoskeletal system pathologies, facilitating the horse to move while its weight is being partially or fully supported by the elevator. Scanning devices include radiography, ultrasound, computed tomography, magnetic resonance imaging, nuclear scintigraphy, thermography, positron emission tomography, endoscopy, and venogram. The aforementioned devices are applied as the diagnostic modalities in numerous pathologies, as well as in cases of a poor equine performance. The AI is the ability of a robot or of a computer to perform the tasks associated with the intelligent beings. In horse breeding, it per-

tains to the devices applied to measure the equine physical activity, heart rate, speed, and movements. The purpose of this technology is to improve the horse's welfare and performance during training. Consequently, the aim of this article is to explain and present the select information and communications technologies deployed in horse breeding.

**Keywords:** ICTs, horse breeding, 3D printing, robots, AI

## Section 5

---

# Digital agroeconomic and marketing





# INFORMATIONAL PLATFORMS AS KEY ENABLERS OF EFFICIENT AND TRANSPARENT SHORT FOOD SUPPLY CHAIN DELIVERY PROCESS

**Snježana Tolić<sup>1</sup>, Ivan Lauc<sup>2</sup>, Duško Rajičević<sup>2</sup>**

<sup>1</sup> Josip Juraj Strossmayer University of Osijek, Faculty of Agrobiotechnical Sciences Osijek, Vladimira Preloga 1, 31000 Osijek, Croatia (snjezana.tolic@fazos.hr)

<sup>2</sup> Reducos j.d.o.o., Sjenjak 39, 31000 Osijek, Croatia

## Abstract

The aim of this paper is to demonstrate how informational technology can be used to improve operational efficiency and information flows in the short food supply chain (SFSC) product delivery process which includes a large number of small food producers.

SFSCs are complex systems due to numerous operations and processes that occur simultaneously. Information technology can track and document activities, then process and communicate data to relevant subjects in the chain. Push-notification system communicates important events to users in real-time. A transport routing engine is needed, as it optimizes deliverer routes for pickups and deliveries, resulting in minimal queue times and fast delivery with minimal product time in transport. Also, it enables route visualization in customer and producer apps. If the initial route is changed, it re-calculates and provides a new optimal route. Results are promptly updated to user and producer apps. This way producers can track deliverers on the way to pick up their products, and customers can track their orders (Figure 1 - customer mobile app). Alerts can be triggered and sent by automation as the deliverer completes previous tasks and moves towards a specific user on the delivery path.

Using modern technologies, it is possible to optimize SFSC business operations to the point where consumers barely feel the difference between SFSC and long chains.

Digital platforms enable short chains' competitiveness in the market by making them more efficient and transparent, thus allowing a sustainable way to supply local communities with fresh, healthy, and often short-life products of small local producers.

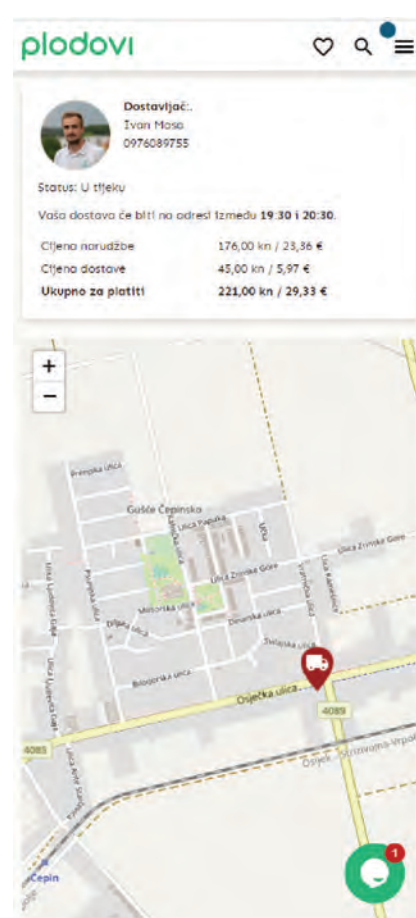

**Figure 1** Customer order tracking with arrival time estimate

**Keywords:** short food supply chain, information technology, small producers.

# INNOVATIVE SUPPLY CHAINS AND LOCAL FOOD PRODUCTION – A CASE STUDY OF THE PLANTON PLATFORM

**Goran Markovanović<sup>1</sup>, Mario Salai<sup>1</sup>, Izabela Novaković<sup>1</sup>, Saša Lamza<sup>2</sup>, Goran Kušec<sup>3</sup>**

<sup>1</sup> PlantOn Ltd., Matije Gupca 74, 31300 Beli Manastir, Croatia

<sup>2</sup> Entrepreneurial Incubator BIOS Ltd., Strossmayerova 341, 31000 Osijek, Croatia

<sup>3</sup> Josip Juraj Strossmayer University of Osijek, Faculty of Agrobiotechnical Sciences Osijek, Vladimira Preloga 1, 31000 Osijek, Croatia (goran.kusec@fazos.hr)

## Abstract

Consumer habits have changed recently, mainly due to the pandemics COVID -19. People are increasingly shopping online and paying more attention to health and nutrition. They want local, fresh, healthy and tested food with a known origin delivered directly to their homes. They also value traceability systems as an important criterion for food quality and safety.

Since Croatia's accession to the EU, there have been frequent reports of lower quality of agricultural products imported at low prices. In fact, food that has been technologically processed for a longer distribution route from production facilities to consumers loses its nutritional value and other quality characteristics. Short supply chains, on the other hand, ensure higher quality food and form the basis for healthier diets. Furthermore, the reduction of gas emissions and energy consumption resulting from the distribution of products is an additional benefit for the community.

Short supply chains mean fewer intermediaries in delivering the product to the consumer. Ideally, the producer should sell directly to the consumer without intermediaries. This is the basic idea behind the PlantOn platform. PlantOn works with small family farms that produce seasonal and mostly organic food. In addition, connecting farmers and consumers in a direct relationship without the intermediation of third parties directly impacts processing, transport, retail and packaging, keeping the supply chain as short as possible.

The PlantOn platform minimizes risk for farmers by allowing them to plan their production thanks to pre-arranged placement, while consumers receive fresh, healthy and verified harvest in recyclable and reusable packaging right at their doorstep.

The problem of traceability is solved by photos and live stream in the application, which discloses production methods and growth to the customer. The platform also provides information on CO2 emissions during delivery. The development of MeatOn platform is pending.

**Keywords:** short supply chains, food quality, food safety, traceability systems

# IMPORTANCE OF USING SOCIAL MEDIA IN PROMOTING FOOD PRODUCTS

**Dubravka Užar<sup>1</sup>, Ivana Varga<sup>2</sup>, Dušan Dunderški<sup>1</sup>, Dario Iljkić<sup>2</sup>**

<sup>1</sup> University of Novi Sad, Faculty of Agriculture, Trg Dositeja Obradovica 8, 21000 Novi Sad, Serbia (dubravkauzar@gmail.com)

<sup>2</sup> Josip Juraj Strossmayer University of Osijek, Faculty of Agrobiotechnical Sciences Osijek, Vladimira Preloga 1, 31000 Osijek, Croatia

## Abstract

Food producers and companies were compelled to adapt and innovate in order to survive the difficult conditions of economic collapse. Food producers' marketing techniques shifted to more online-based social media services as a result of social distancing. In recent years, social media has emerged as a new commercial communication tool. For the time being, employing social media as an effective and efficient advertising tool may quicken the growth of the food industry. There are various advantages to using social media to promote food products. Social media provide opportunities for food companies and producers for finding diverse sales channels and also can receive direct feedback from customers by using an online feedback system. The first objective of this study is to review the academic literature pertaining to social media adoption. The qualitative research approach is utilized in this study to examine how food companies and producers interact with their customers online and use social media as a strategic tool of social network marketing. Previous research indicates that more than 60% of food companies and producers in the EU believe that one of the most important benefits of social media adoption and usage is brand building, with the ability to inform customers about new products, contests, customized offers, and awards. Serbian food companies are increasingly establishing the importance of creating profiles and using social media's benefits. In support of this, 47.4% of companies have been using social networks for the needs of the company's business. Food producers should embrace technological innovations and use new media to engage audiences and consumers more closely than ever before. Finally, implications for policy and practice are suggested and knowledge gaps and opportunities for future research are identified.

**Keywords:** food, social media, companies, producers

## Section 6

---

# Agronomist education in digital agriculture



# MULTIMEDIA TOOLSET DEPLOYMENT IN THE ENGLISH-COURSE PRESENTATION OF DIGITAL AGRICULTURE

Tihomir Živić

Josip Juraj Strossmayer University of Osijek, Faculty of Agrobiotechnical Sciences Osijek, Vladimira Preloga 1, 31000 Osijek, Croatia (tihomir.zivic@fazos.hr)

## Abstract

In a general aspect of teaching English as a foreign language (TEFL), English as a foreign language (EFL) may be considered as stimulating to the English language learners (ELLs) - that is, to the speakers of Croatian as their native language - because the TEFL practice in that particular case refers to English language teaching in a European Union (EU) country whose official language is other than English. Additionally, to contribute to a desirable students' English proficiency level in the scope of a comprehensive agronomist education - that is, the one that progressively relies on the digitalization process and technological advancements in the agricultural sector - various learning methods are being applied, frequently favoring the so-called blended learning as a technology-mediated, or a web-enhanced, personalized learning policy. Consequently, a partially self-directed study at home via e-learning platforms (e.g., the Moodle-based course management systems such as *Merlin*) was especially promoted at the time of the COVID-19 pandemic, having remained fully operational in case of the *English in Digital Agriculture* course too.

As the course lectures of the Graduate Study Program in Digital Agriculture are delivered exclusively in English, thus empowering the students to experience a complete Anglo-American cultural immersion, native speaker interaction, and peer tutoring as well, this paper's objective is to examine the avenues in which the future English in Digital Agriculture e-textbook might successfully reference the necessary linguistic habits and internal mechanisms to assist the students' acquisition of a proper pronunciation, syntax, and vocabulary, predominantly engined by the formal and vernacular English language of the United States of America.

To alleviate the difficulties and surmount the students' obstacles while being involved in an English for specific purposes (ESP) course, the aforementioned

e-textbook applied a contrastive analysis approach to this type of the English for academic purposes (EAP) scheme. In-text bolding and bookmarking were utilized in the English typescript to demarcate and define a new terminology of Digital Agriculture in a follow-up glossary, and the smartphone-scannable QR codes of the hyperlinked, thematically correspondent *YouTube* video clips were introduced to potentially eliminate the hypothetically problematic Croatian transfer effects, especially the students' false part-of-speech identification; an occasionally objectionable mispronunciation of English diphthongs, interdentalals such as /θ/ and /ð/, and silent letters; or the vocabulary-related false friends.

In terms of the English grammar, the e-textbook exercises provide for an adequate practicum material concerning the verbal aspects, moods, and tenses, with a special emphasis put on the auxiliaries and modals. Equal attention is meticulously devoted to the issues of English definite, indefinite, and zero articles, as well as to the topic of select agricultural and general idiomaticity. When it comes to the preselected English lexicon, however, the e-textbook incorporates the authentic articles styled in Standard American English (StAmE) to illustrate the collocations, most frequent phrasal verbs and prepositions, and word formation patterns. Eventually, to enhance the students' second-language literacy, to correctly contextualize the English vocabulary in the domain of Digital Agriculture, and to sociolinguistically rectify the students' recurrent register errors, a clear distinction is purposely made between the English colloquialisms, formal language, and slangue as well.

*English in Digital Agriculture* e-textbook thus represents a formal-content learning material, with an emphasis placed on the students' basic interpersonal communication skills (BICS) in the English language and their cognitive academic language proficiency

(CALP). Thanks to the benefits of the advanced educational technologies, or edutechs, deployed, the e-textbook aspires to create the foundation for a confidence-building, responsible, and stress-free class environment, completely equipped and suitable for a modern, slightly gamified computer-assisted language learning (CALL). While fully embracing the principle of a multicultural, inquiry-oriented lesson format, or WebQuest, the e-textbook actually provokes the students to initiate a topical, Web-based information search of their own - occasionally in the form of an extracurricular activity - to finally overcome the language barriers, voice their opinions, and perfect their writing skills with respect to various issues in contemporary Digital Agriculture.

The e-textbook's multimedia contents semantically and syntactically comply with the C<sub>1</sub> and C<sub>2</sub> levels of the Common European Framework of Reference for Languages (CEF), but the exposure to the native speakers' oral and textual styles and a peer tutoring advocacy and tolerance might effectively and ethically assist in the neutralization of educational inequality, or students' achievement gaps, facilitating the students' English-based professional and technical communication in the sphere of Digital Agriculture.

Qualifying the students for an ultimately elevated academic performance when it comes to their ESP expression, the e-textbook might consequently and conclusively be observed as a form an interactive, self-paced, and student-centered ecosystem that involves the students in an almost coauthorial, feedback-providing role in the field of the so-called citizen science, in this case ranging from the classical agronomic topics such as the viticultural terroirs all up to rurism - that is, a rural landscape beautification, increasingly performed by virtue of a digital transformation.

**Keywords:** agronomist education, Digital Agriculture, English language acquisition, innovation, technological advances

## Acknowledgment

The author wishes to express his profoundest gratitude to the Croatian chapter of the Digital Research Infrastructure for the Arts and Humanities (DARIAH-EU) for the provision of a valuable insight and a hands-on experience concerning the referenced language technologies.



# COMPETENCE, PERSPECTIVE AND POTENTIAL ROLE OF AGRONOMISTS IN AGRICULTURE DIGITALIZATION IN CROATIA

**Dominik Tačković, Ružica Lončarić, Sanja Jelić Milković, Zdenko Lončarić**

Josip Juraj Strossmayer University of Osijek, Faculty of Agrobiotechnical Sciences Osijek, Vladimira Preloga 1, 31000 Osijek, Croatia (dominik.tackovic@fazos.hr)

## Abstract

Intensive agricultural production, without proper management, will probably cause soil degradation. Therefore, monitoring soil quality in agricultural regions is essential for soil protection. Analytical results of soil properties can be successfully combined with mathematical and/or computer models to predict values of soil indicators that have not been analytically determined. In doing so, it is very important to determine as accurately as possible which properties determine the intensity of a certain soil indicator to the greatest extent. Iron is an essential element whose availability in the soil depends significantly on the total concentration of Fe in the soil, soil pH value and SOM content, and the lack of plant available Fe can limit production on poor, especially carbonate soils. The aim of this research was to determine the possibility of using available data to predict Fe availability with regression models. The regression model was created using a data set with the results of analysis of Fe concentration in more than two hundred soil samples (total Fe extracted with aqua regia in the range 2-3.9% and plant available Fe in the range 10-45 mg kg<sup>-1</sup>). The model was used to predict the available Fe based on the analysed soil properties (pHH<sub>2</sub>O, pHKCl and SOM content) of 1,000 soil samples with the total analysed production area 5,194 ha.

Modeling available Fe on a new set with 1,000 soil samples predicted that the low concentration of available Fe will be only on 1.83 % of analysed areas, which is just 95 ha. The moderate range of plant available Fe was predicted at 245 ha (4,72 % area). High level of Fe availability was predicted at 93,45 % area, i.e. on 4.854 ha. The model predicts a very small proportion of samples with a low Fe available to the plant, which leads to the assumption of low accuracy of the model, even though SOM and two pH values were used. If that's the case, a data set with basic soil indicators is not sufficient to predict Fe availability.

The demonstrated use of the model indicates that modeling can be effectively used to predict certain soil indicators without actual laboratory analysis, saving time and resources. This can be especially significant in cases of a large number of soil samples from different and heterogeneous production areas. However, the accuracy of the model must be validated, which is possible only by validation with a reasonably selected new set of samples and analytical results. Thereby, it is more likely that analyzes of additional soil properties (like percentage of clay particles, total amount and different fractions of Fe) will be required in addition to the basic soil analyses (pHH<sub>2</sub>O, pHKCl and SOM content).

**Keywords:** availability modeling, regression model, EDTA, Fe

## Acknowledgement

This work was supported by the Huawei „Seeds For The Future Scholarship Programm“.

# KNOWLEDGE ON DIGITAL AGRICULTURE AMONG THE OWNERS OF FAMILY FARMS IN OSIJEK-BARANJA COUNTY

**Dinko Domazetović<sup>1</sup>, Ružica Lončarić<sup>2</sup>, Sanja Jelić Milković<sup>2</sup>, Zdenko Lončarić<sup>2</sup>**

<sup>1</sup> Master study Digital agriculture, Josip Juraj Strossmayer University of Osijek, Faculty of Agrobiotechnical Sciences Osijek, Vladimira Preloga 1, 31000 Osijek, Croatia (dinkodomazetovic@gmail.com)

<sup>2</sup> Josip Juraj Strossmayer University of Osijek, Faculty of Agrobiotechnical Sciences, V. Preloga 1, Osijek, Croatia

## Abstract

The main aim of the proposed research will be to determine the level of current knowledge and awareness about recent trends and applications in digital agriculture among the owners of family farms in Osijek-Baranja County. Through this study, it will be determined how much knowledge farmers currently have in the field of digital agriculture and more importantly how willing are they to implement new technologies in their daily agricultural activities. The online and face to face survey was conducted among 43 family farmers in Osijek-Baranja County during summer 2022. One part of the study will determine which aspects of digital agriculture are already in use among the owners of family farms and which are the most common obstacles and problems they are facing in relation to the broad implementation of digital agriculture. In survey participated mostly men (76,7%), 42 years old in average, most of their income comes from agricultural activities (56%), 58% has some kind of college or faculty education, they have been engaged in agriculture for less than 10 years (44%) and have only 1 employee (69%). In survey participated farmers from almost all fields of agriculture from tourism, beekeeping, farming, eco-agriculture, cattle production, winemaking, and others. 56% of respondents were acquainted with the terms Precision agriculture, 67% with Digital agriculture, and 72% with Artificial intelligence. Applications already implemented in agricultural activities mostly are internet and communications (88%) and e-government (62%), applications for weather applications (46%) and market access applications (25%) but in the future they plan to adopt other applications (for fertilization, soil protection, e-accounting, precision agriculture, drones and other). Using Likert scale from 1 to 5, the main obstacles and limitations in digital agriculture for respondents are large investments for machinery and equipment (4,0), lack of advisory service (3,9) and

lack of qualified and trained workforce (3,9). The most important subjects for implementing digital technologies in agriculture are agronomists and extension services (average score on Likert scale 4,2 for both) as well as educational and scientific institutions (4,16). 63% of surveyed subjects advertise their business on social media, mostly on Facebook. Less favorable answers in survey are that 65% of producers don't have a web page for their manufacturers and 77% didn't use EU funds for digitalization. The conclusion from this survey is that Croatia has only started its introduction to digitalization, and there is a lot of space for progress and the introduction of new technologies. A positive push would be the creation of a countrywide strategy on which technologies should be implemented. Also, the involving agronomists would improve education, data collection, extension activities and supervising the implementation of digital technologies.

**Keywords:** family farms, digital technologies, knowledge, education

## Acknowledgement

This work was supported by the Huawei „Seeds For The Future Scholarship Programm“.

# APPLICATION OF THE CONCEPT OF SMART VILLAGES TO THE DEVELOPMENT OF THE VILLAGE OF BANOVA JARUGA

Lucija Magdić<sup>1</sup>, Snježana Tolić<sup>2</sup>, Josip Job<sup>3</sup>

<sup>1</sup> Master study Digital agriculture, Josip Juraj Strossmayer University of Osijek, Faculty of Agrobiotechnical Sciences Osijek, Vladimira Preloga 1, 31000 Osijek, Croatia (lmagdic@fazos.hr)

<sup>2</sup> Josip Juraj Strossmayer University of Osijek, Faculty of Agrobiotechnical Sciences Osijek, Vladimira Preloga 1, 31000 Osijek, Croatia

<sup>3</sup> Josip Juraj Strossmayer University of Osijek, Faculty of electrical engineering, computer science and information technology Osijek, Cara Hadrijana 10b, 31000 Osijek, Croatia

## Abstract

The integration of elements and principles of a smart village into traditional and new economic structures, networks and services such as digital and telecommunication technologies and better use of knowledge increase the attractiveness of rural settlements for local residents and entrepreneurs. Application of the concept smart villages are important for the further development of rural areas - for the development of agriculture, tourism, public services, mobility and more. Materials for this research are collected by analyzing the existing development documents of the village of Banova Jaruga, analysis of development documents of LAG Moslavina and survey research to determine development potentials and constraints to define the needs and opportunities of this area and develop new ideas with emphasis on the digitization and application of the concept of smart villages in the function of stronger development. Among the scientific methods, the methods of analysis, comparison, SWOT analysis and survey are used. Banova Jaruga, with its favorable traffic location and favorable traffic connections, is potentially a very attractive village, but like most villages in Croatia, poorly developed. From the results obtained in the survey, the majority of the population up to the age of forty does not know what digitization of the village is. Education for the purpose of raising awareness about digitization in rural areas is almost non-existent. There is no development strategy for the city of Kutina, there is only a development strategy for the expansion of broadband internet. As a start in digitalization, this is a good first step. LAG Moslavina has a development strategy in general for all villages that fall under their influence. Some of the strategies that can be implemented in the near future are reducing the digital gap, reducing

the costs of health services using e-health, increasing the education of the population through e-education including distance learning, increasing the competitiveness of the economy by introducing digital components in agricultural farms. Also, according to the results obtained in the survey, the majority of the population would use some of the examples offered. Finances for investment in the creation of smart villages are limited and low, and thus we come to the problem of slow development. Modernization of villages is necessary, as well as permanent education of farmers and highly educated staff of young people who can handle changes. It is very important to find the right model of village renewal in Croatia.

**Keywords:** development, digitalization, education, smart village, strategy

## Acknowledgement

This work was supported by the Huawei „Seeds For The Future Scholarship Programm“.

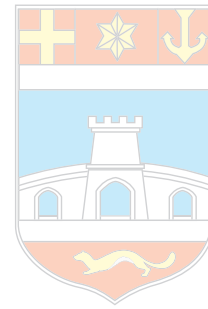
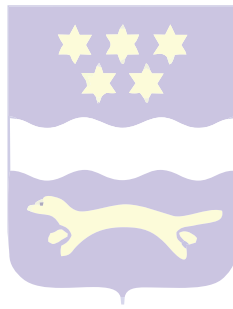

 **AGRIVI**

 **žito**  
grupa

